

# MUTATIONS™

## TEENAGE MUTANT NINJA

# TURTLES®

### Assembly

- Attach Jumbo Turtle collar to Turtle shell behind the foot foilin' Turtle head as shown.
  - Snap the fierce side fenders (2) to sides of Turtle shell as indicated.
  - Plug rear hatch to back of Turtle shell as shown.
1. To mutate from jumbo Turtle to Foot-crushin' Carrier:

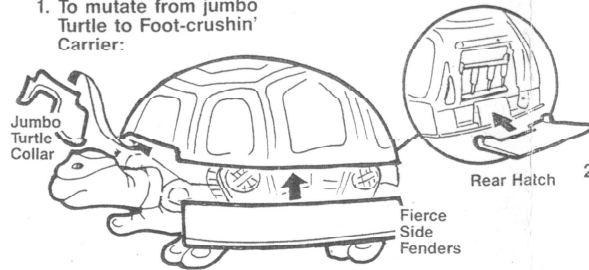

4. Flip the Turtle back over. Fold down the rear hatch and flip the Turtle shell over to mutate into the Turtle troop container.

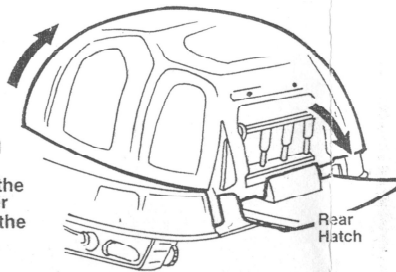

2. Roll the Turtle over on his back to expose his mutatin' belly. Fold out the real-rollin' wheels. Fold in the fancy feet and tail under the foot proof Turtle shell.

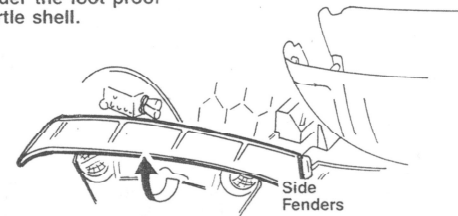
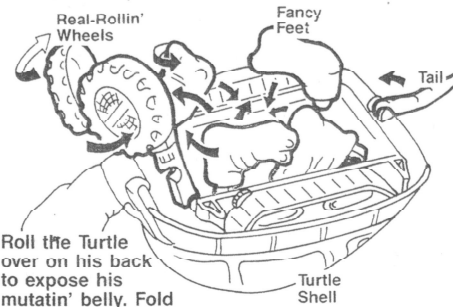

5. Swing up the fierce side fenders.

3. Pull up the set of hard shelled half-tracks, until they lock in place.

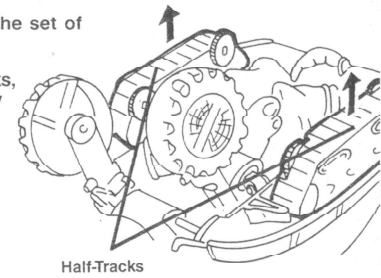

6. Pop-up the wacky windshield and side windows. Lock the windows into position by inserting into windshield grooves. Slide the Turtle troop container forward until fenders are above wheels and lock into position.

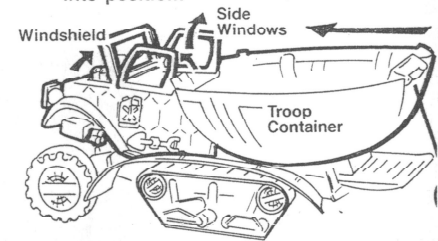

7. Pull-up the powerful piston engine and rotate forward the 2 mutant machine guns.

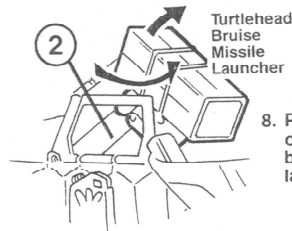
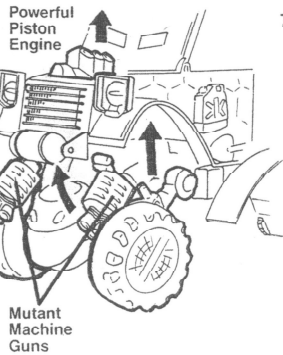

8. Pull up and swing out the Turtlehead bruise missile launcher.

- Place the 4-Turtlehead bruise missiles into the missile launcher (when Turtlehead bruise missiles are not in use attach missiles to posts inside Turtle troop container). Snap the 2-muta-carrier headlights onto the front fenders. Plug the sideswipe shovel and mutant gas can to the drivers side door.
  - Place labels 1-14 as shown.
- Directions
- Place your favorite Turtle teens into the drivers seat and the Turtle troop container.
  - Wait for the pad boys to come and get the teens, then you surprise them by launching the Turtlehead bruise missiles.

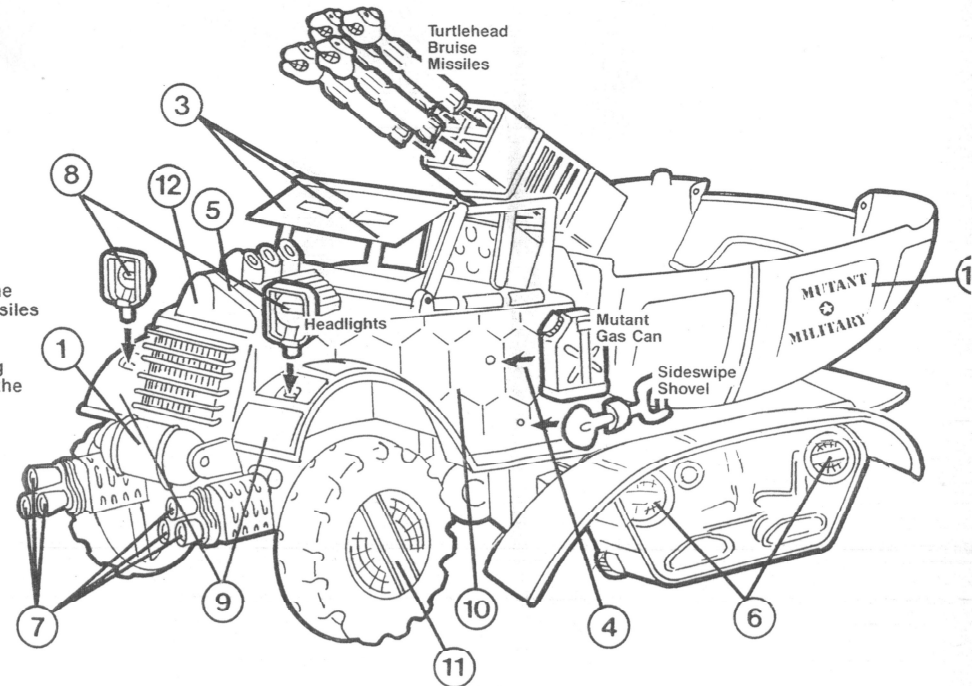

Note: To mutate back into the Jumbo pet Turtle, just reverse the directions above.

