

nickelodeon

LEGO

TEENAGE MUTANT NINJA TURTLES



79121



WARNING: CHOKING HAZARD.
Toy contains small parts and a small ball.
Not for children under 3 years.

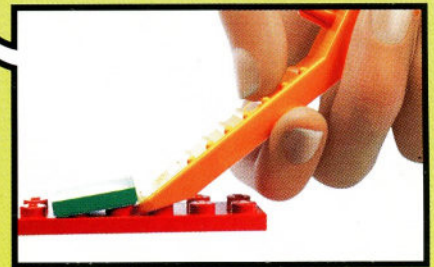
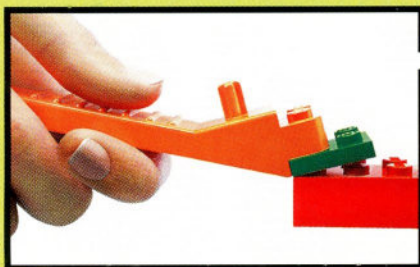
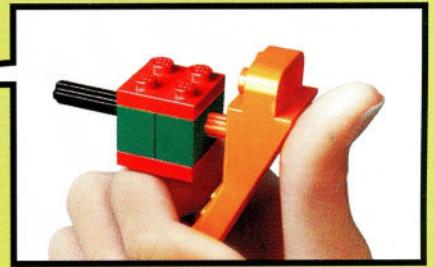
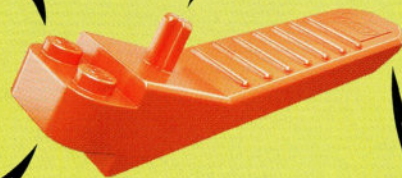
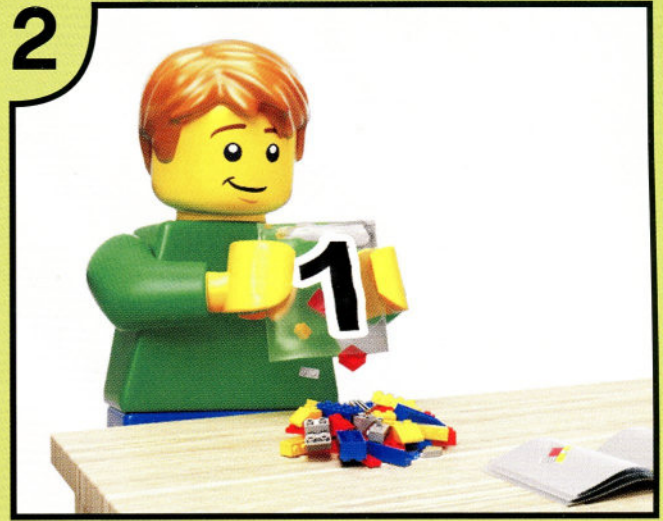

LEGO.com/brickseparator

IMPORTANT: Never modify the elements or use other projectiles than provided with this toy.
IMPORTANT : Ne jamais modifier les éléments ni utiliser d'autres projectiles que ceux fournis avec ce jouet.
IMPORTANTE: No modificar los elementos ni utilice otros proyectiles diferentes a los suministrados junto con este juguete.

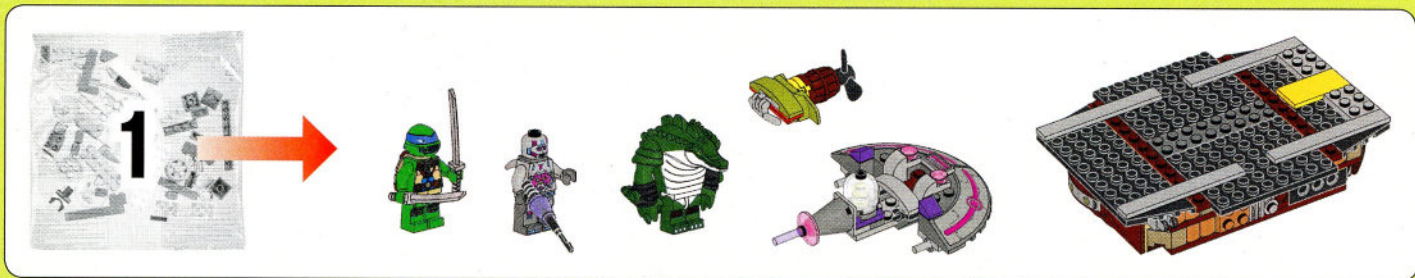

⚠ **AVERTISSEMENT** : RISQUE D'ÉTOUFFEMENT.
 Le jouet contient des petites pièces ainsi qu'une petite boule.
 Il ne convient pas aux enfants de moins de 3 ans.

⚠ **ADVERTENCIA**: PELIGRO DE ASFIXIA.
 Juguete que contiene partes pequeñas y una pelota pequeña.
 No recomendado para niños menores de 3 años.

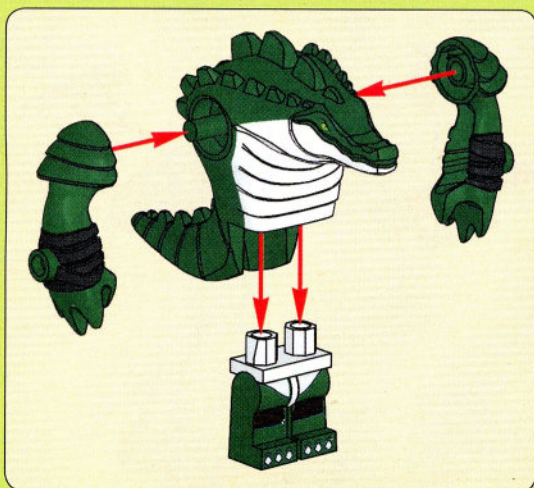
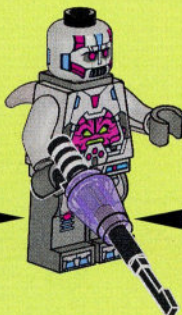
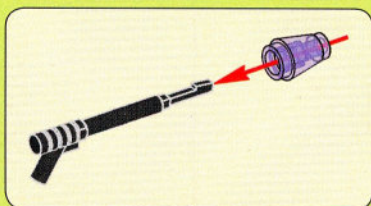
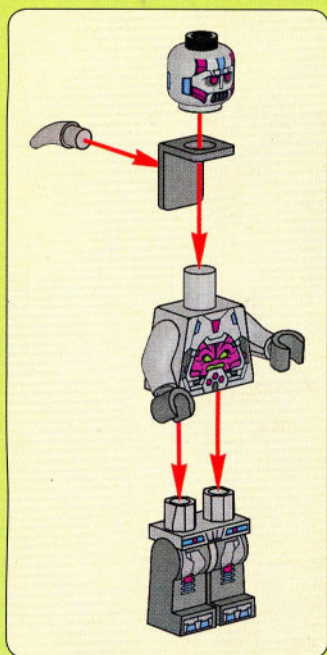



1x



1

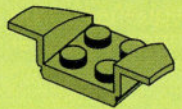

2x

2

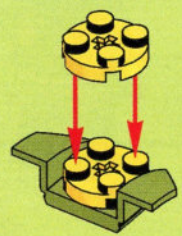

1x

3

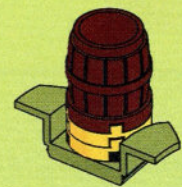

1x



1x



1x



1x

4

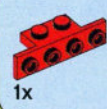
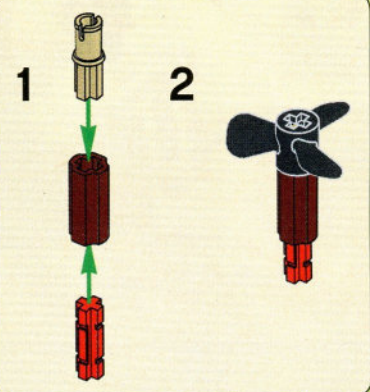

1x

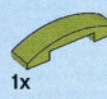

1x



1x



1x

5

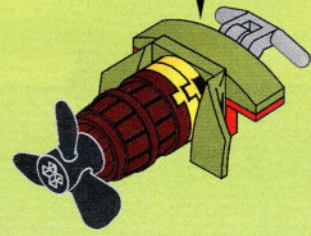
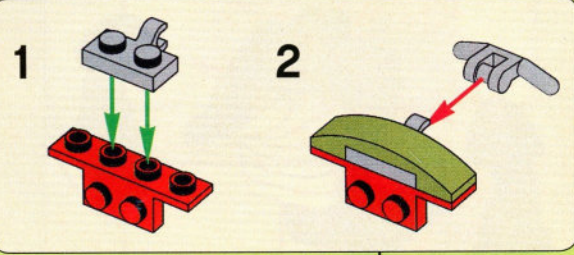

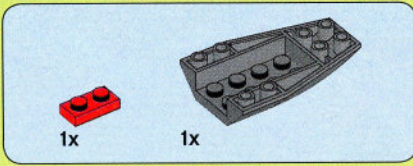
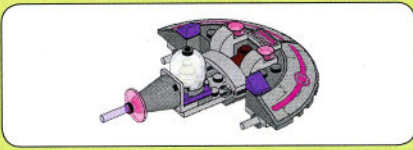

1

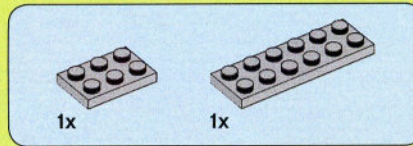
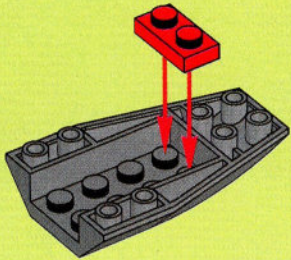

2

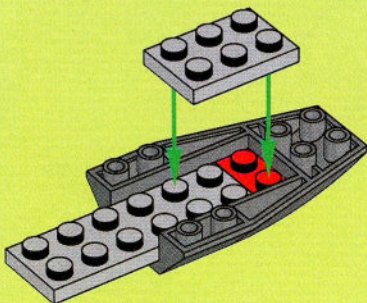

3

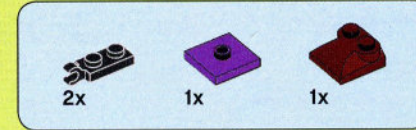
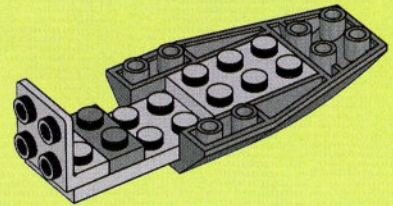

4

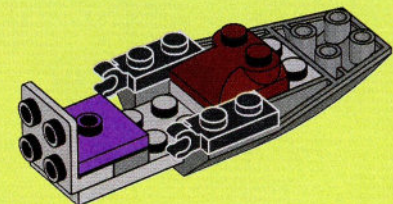

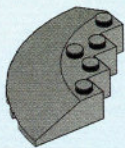

2x

5

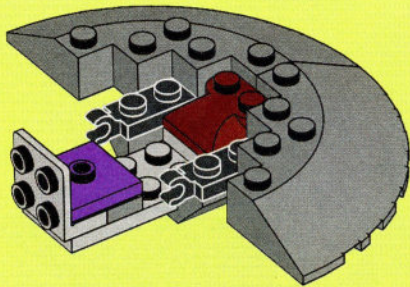

7

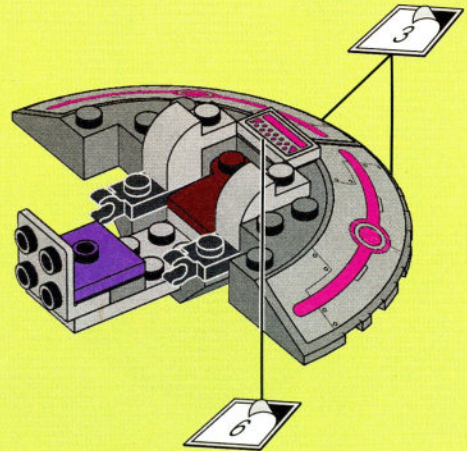

1x



2x

6

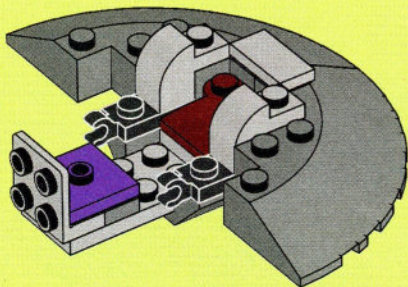

1x



2x



2x

8

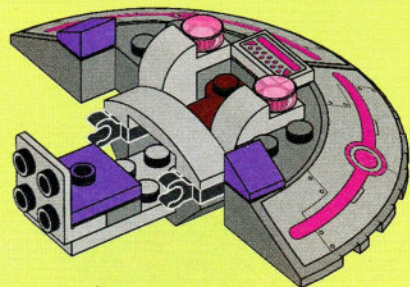

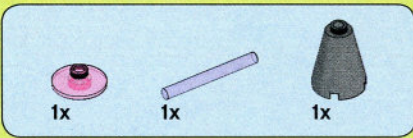

9

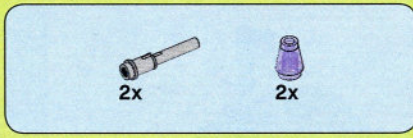
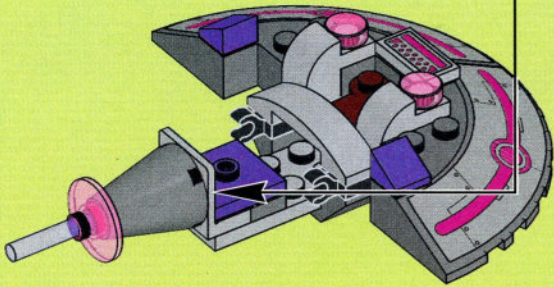
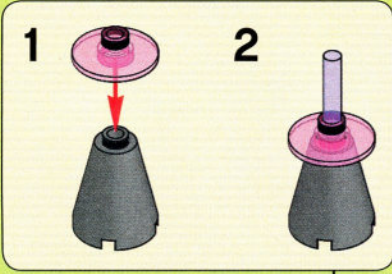

11

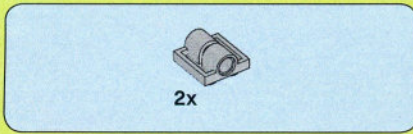
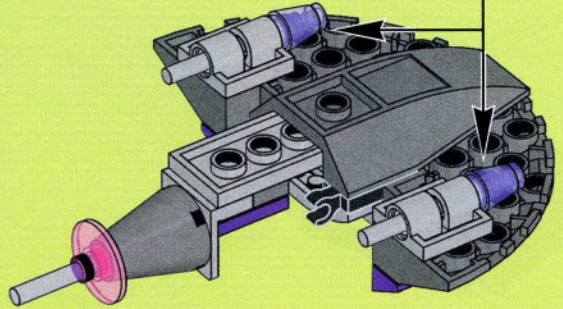
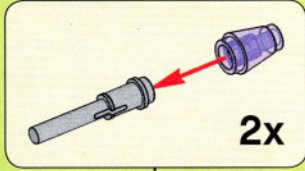

10

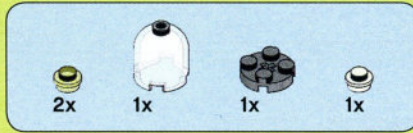
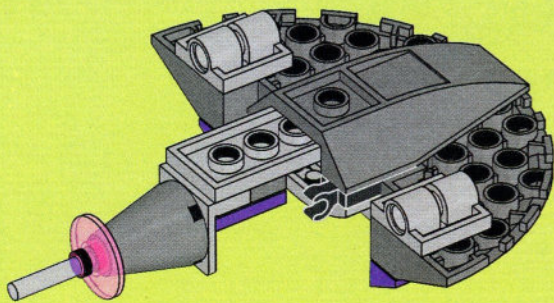

12

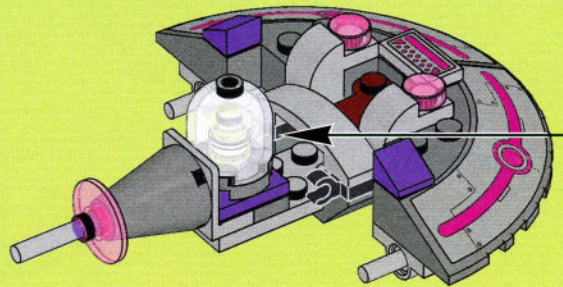
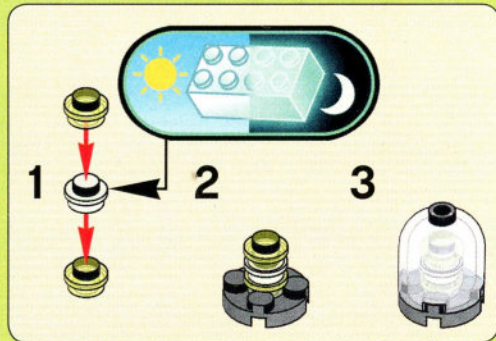

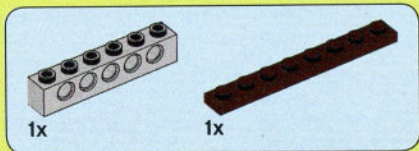
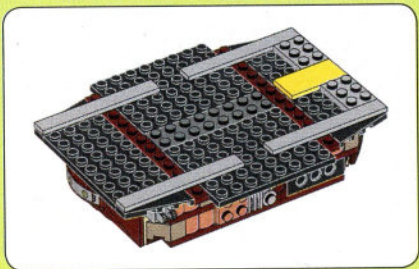
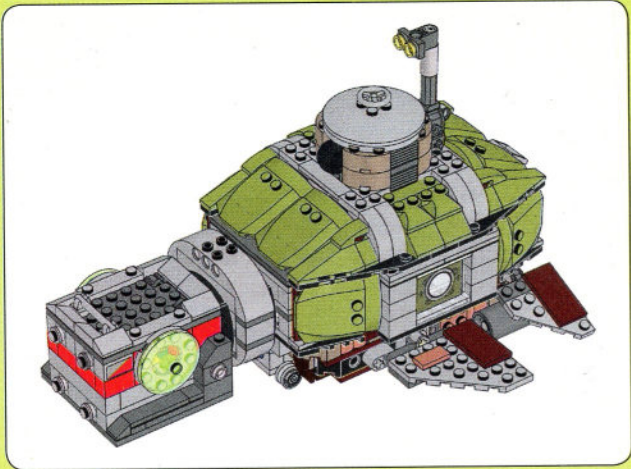

1

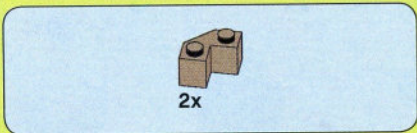
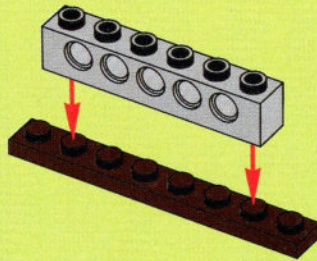

2

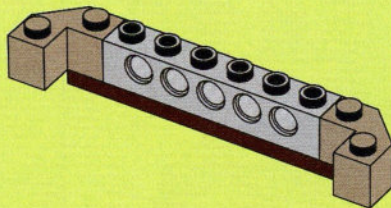

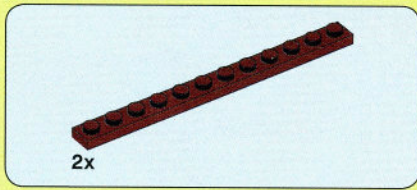

3

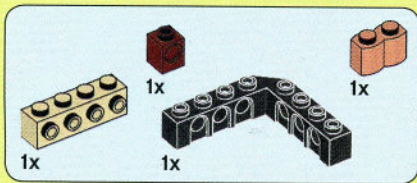
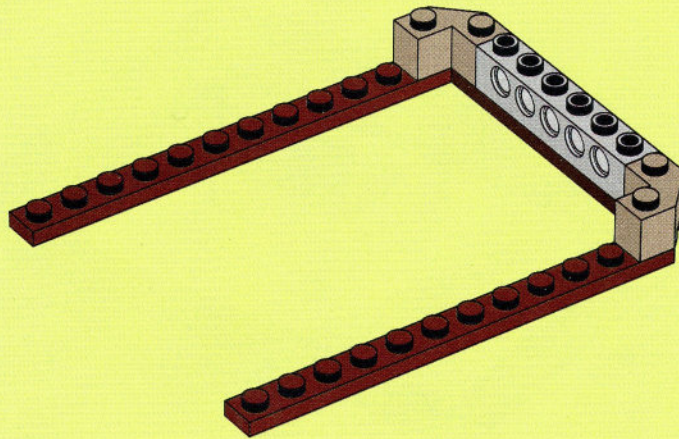

4

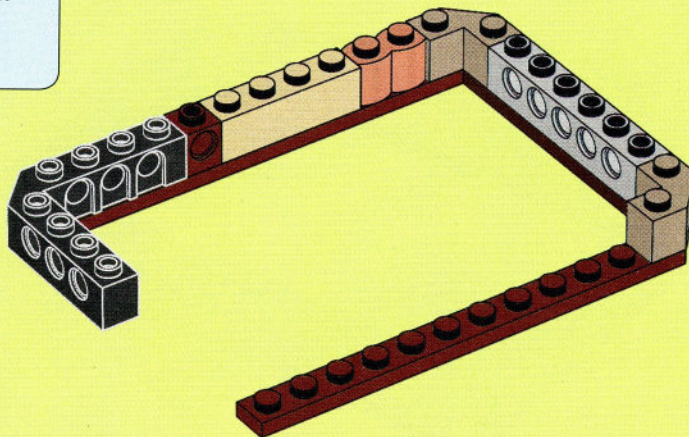

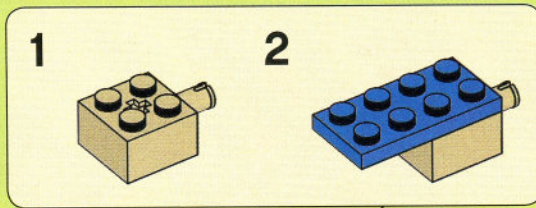
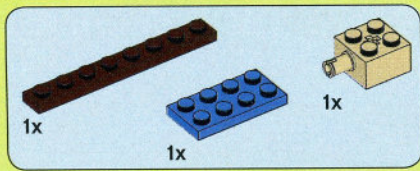

5

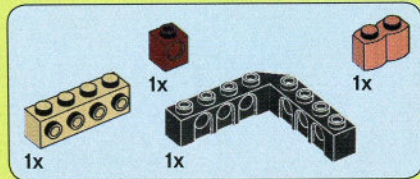
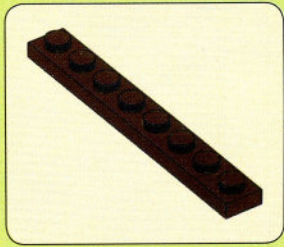
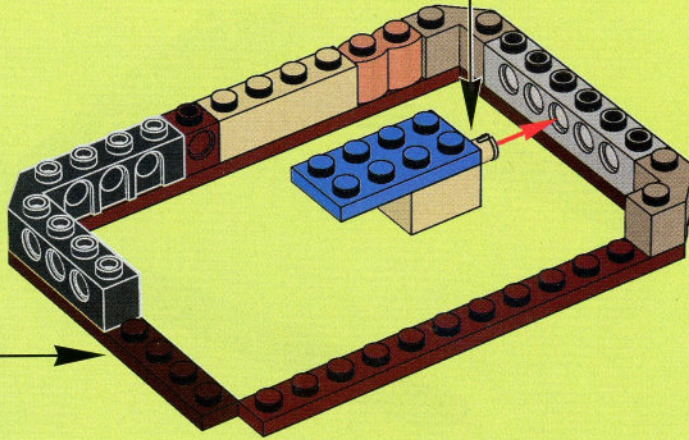

6

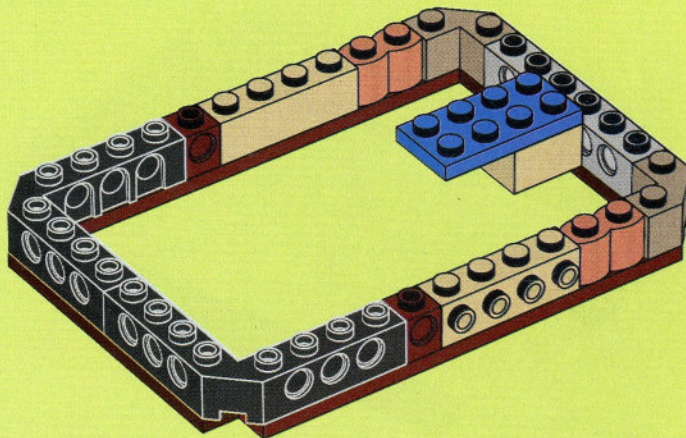



2x



2x

7

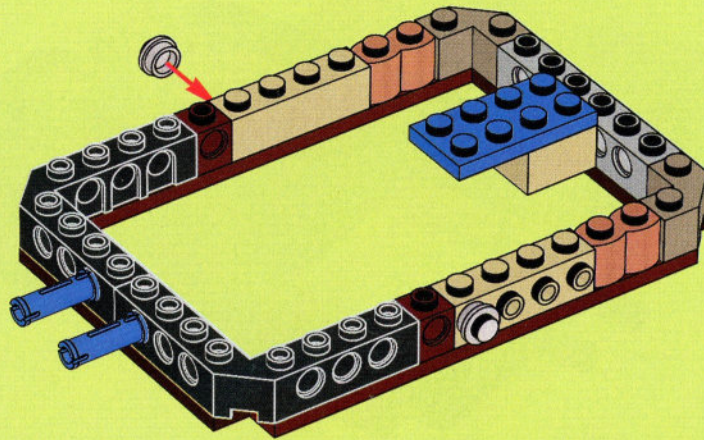

2x



3x



1x

8

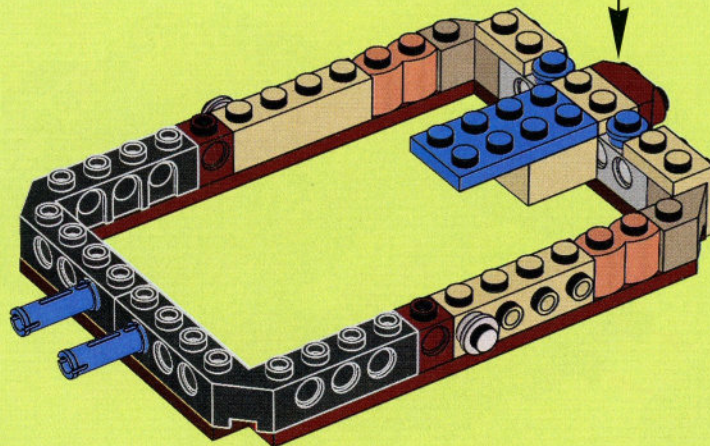
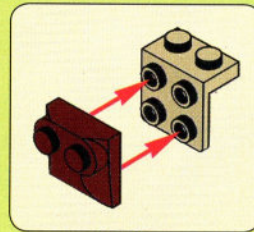

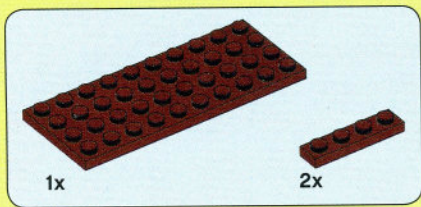

9

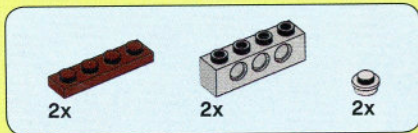
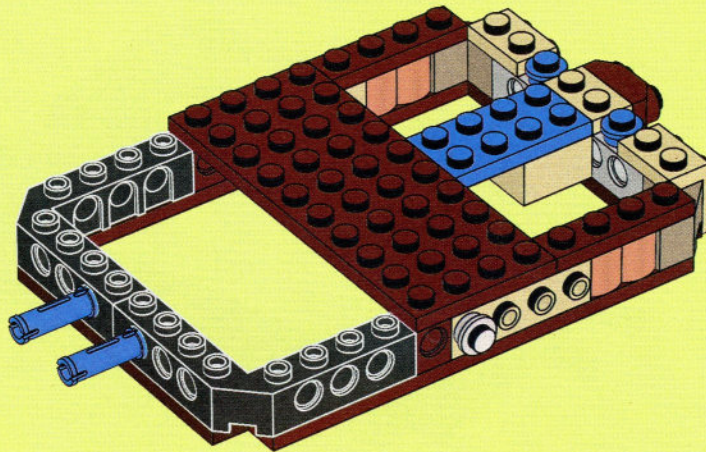

10

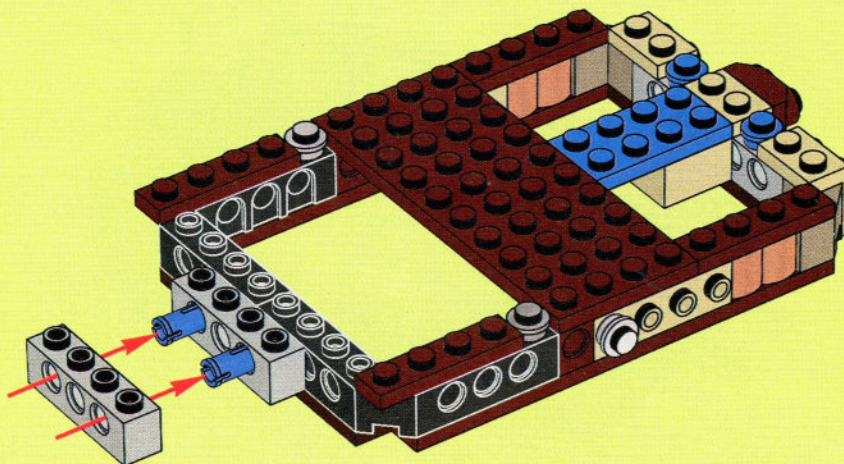

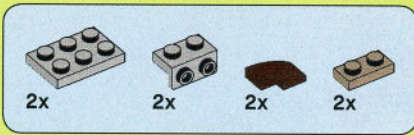

11

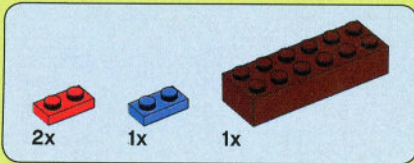
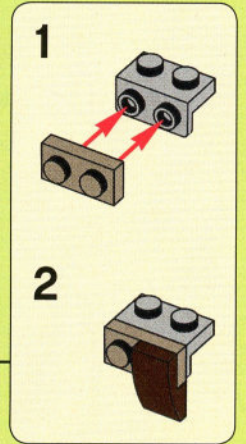
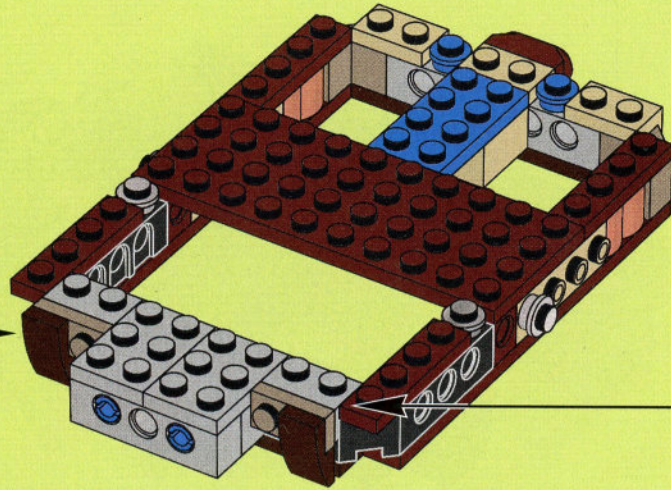
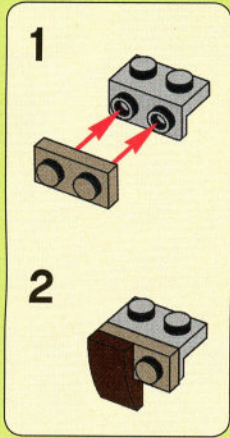

12

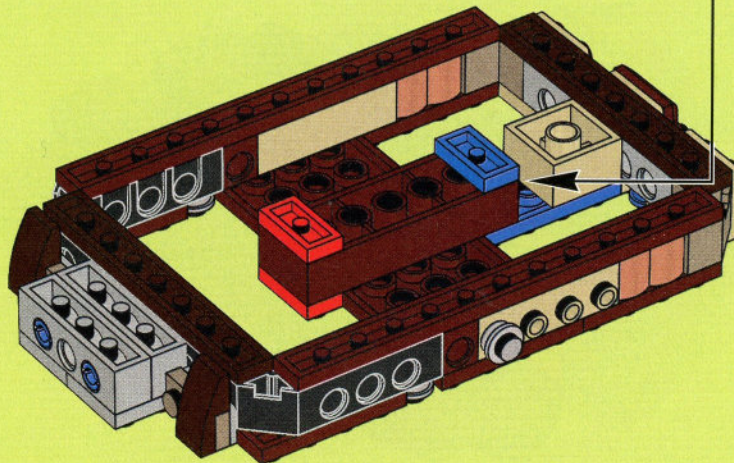
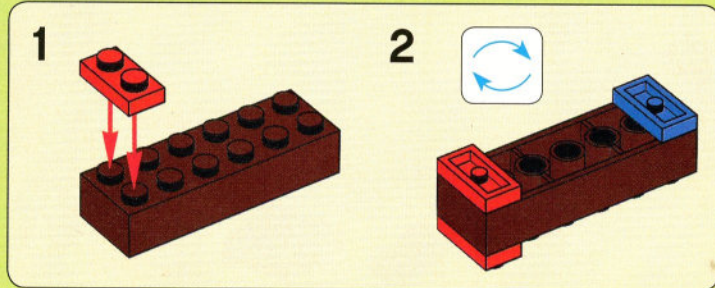

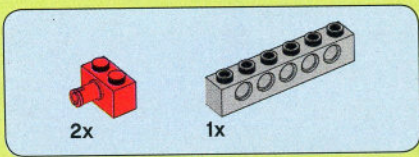

13

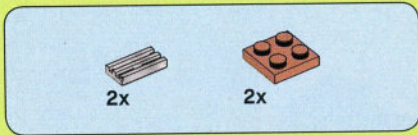
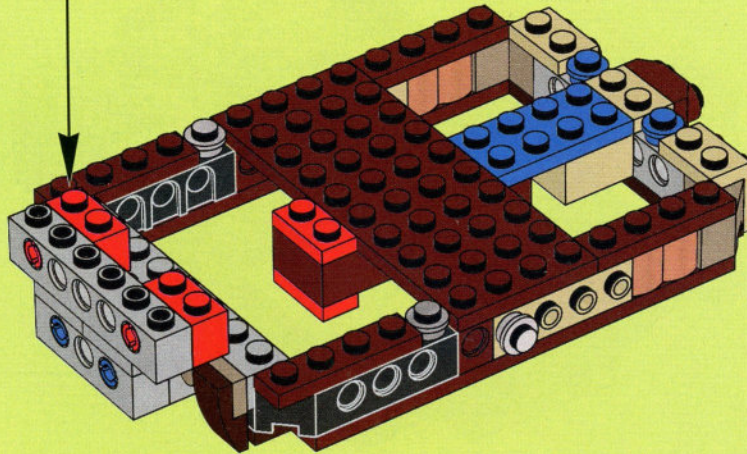
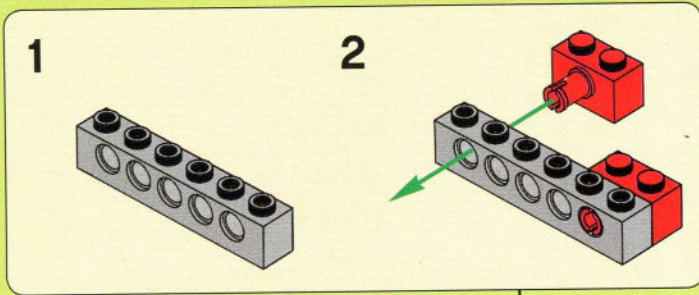

14

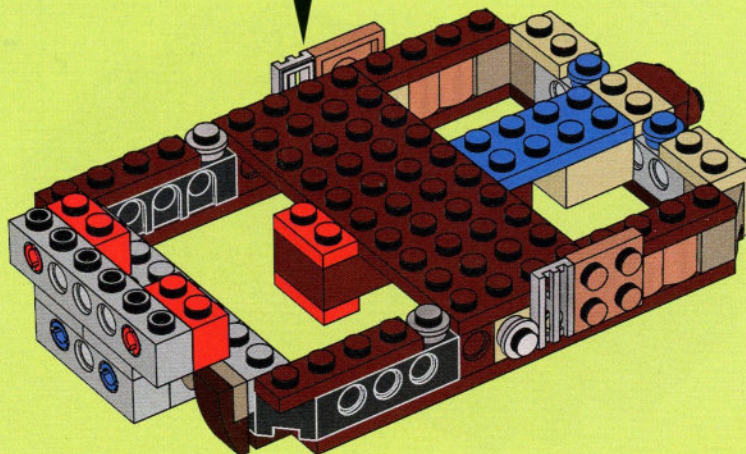
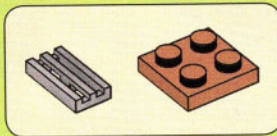

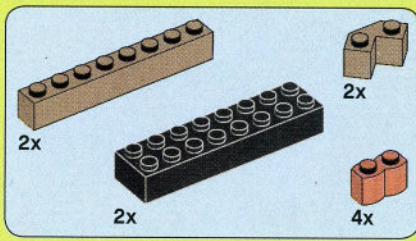

15

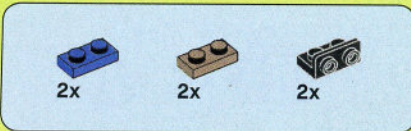
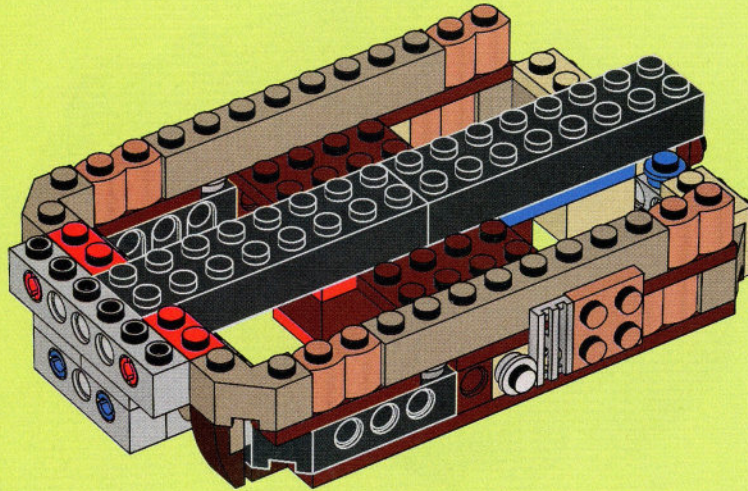

16

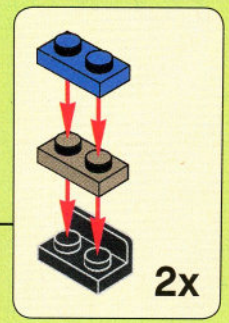
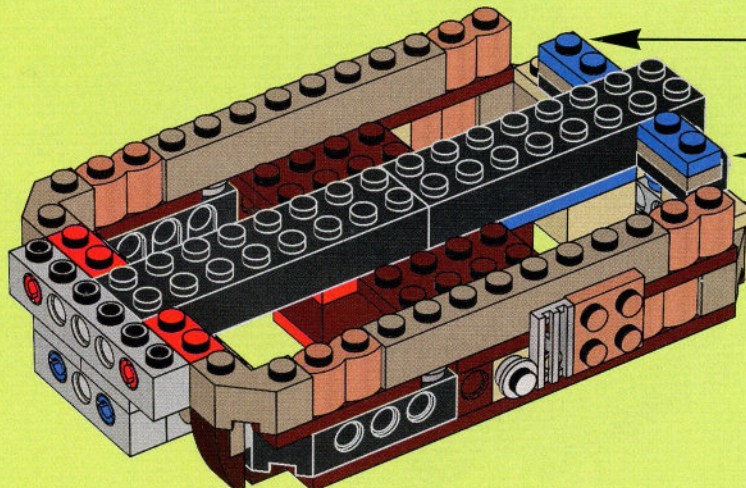

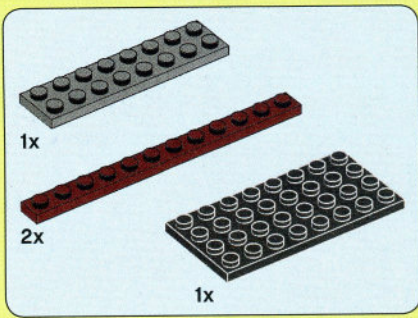

17

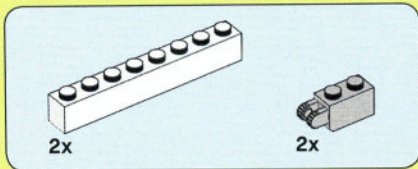
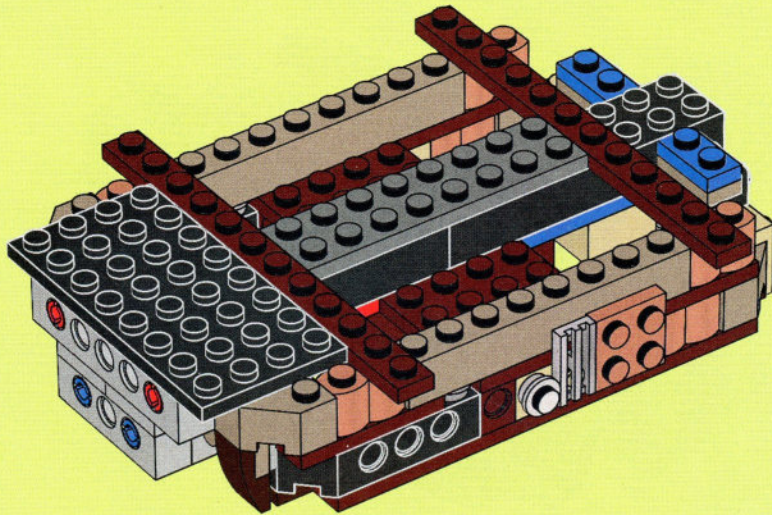

18

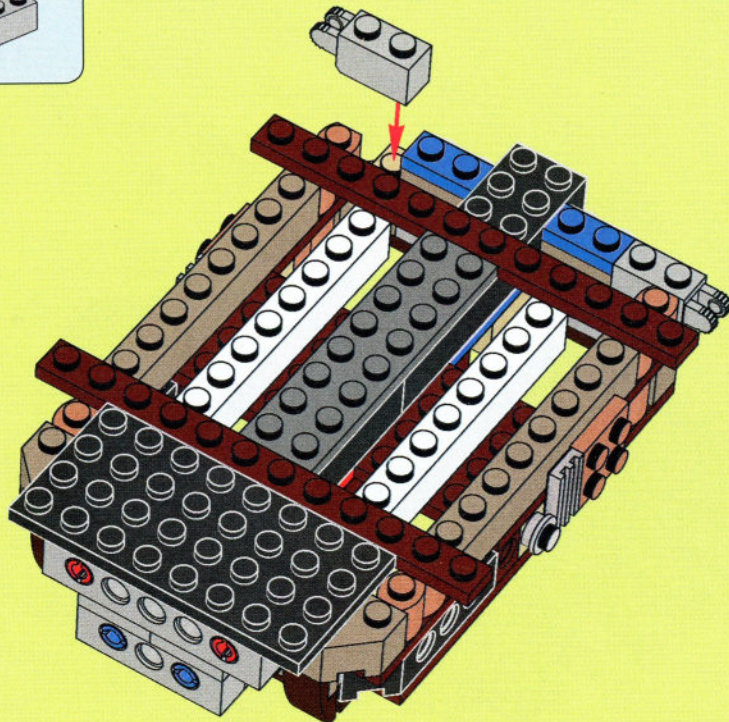

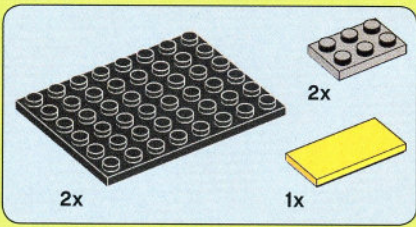

19

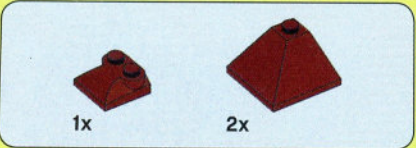
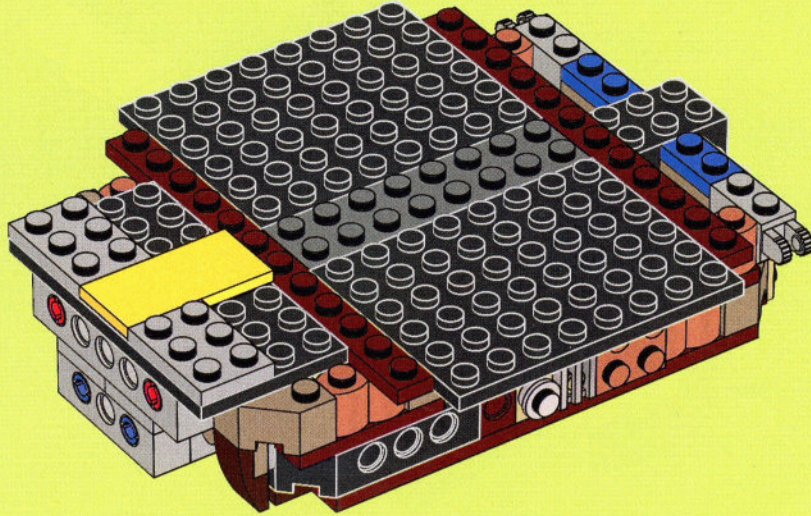

20

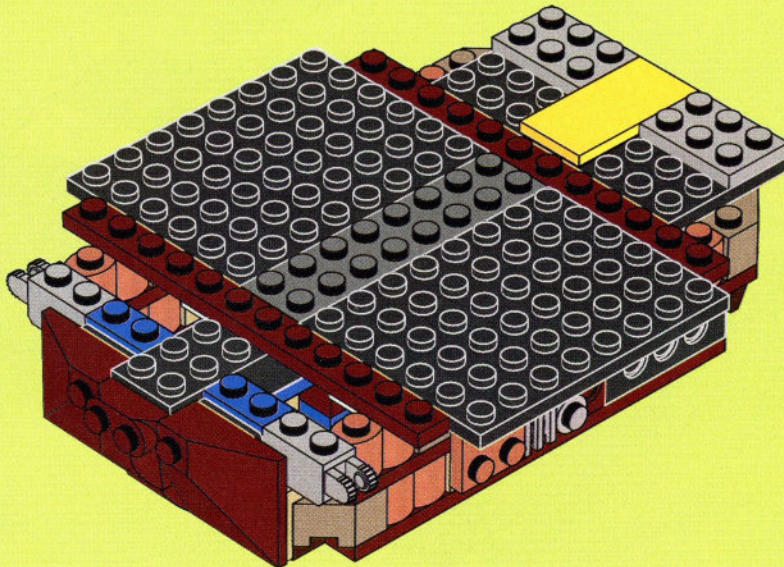

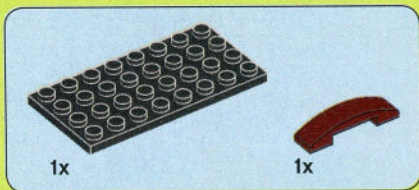

21

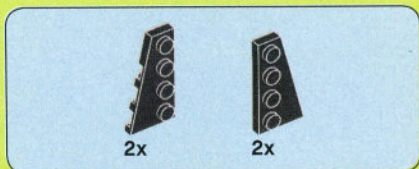
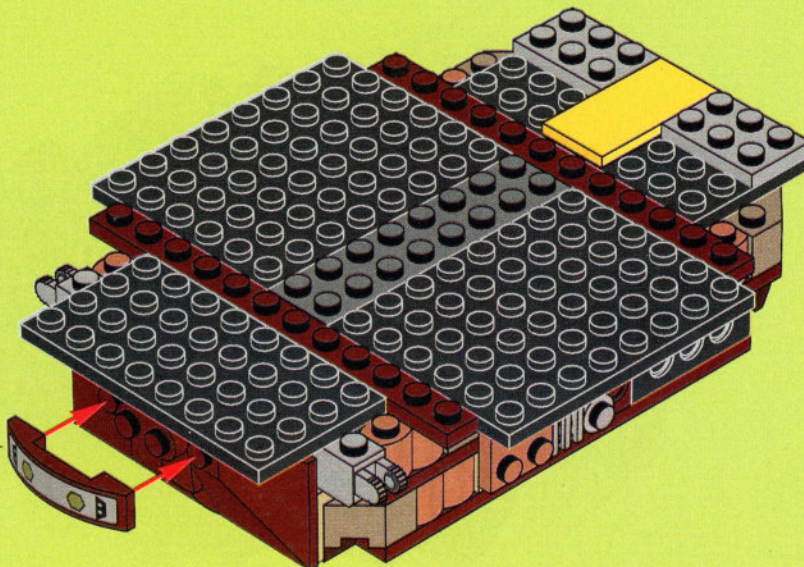
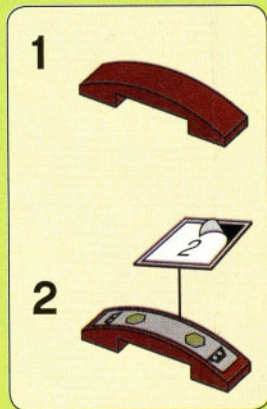

22

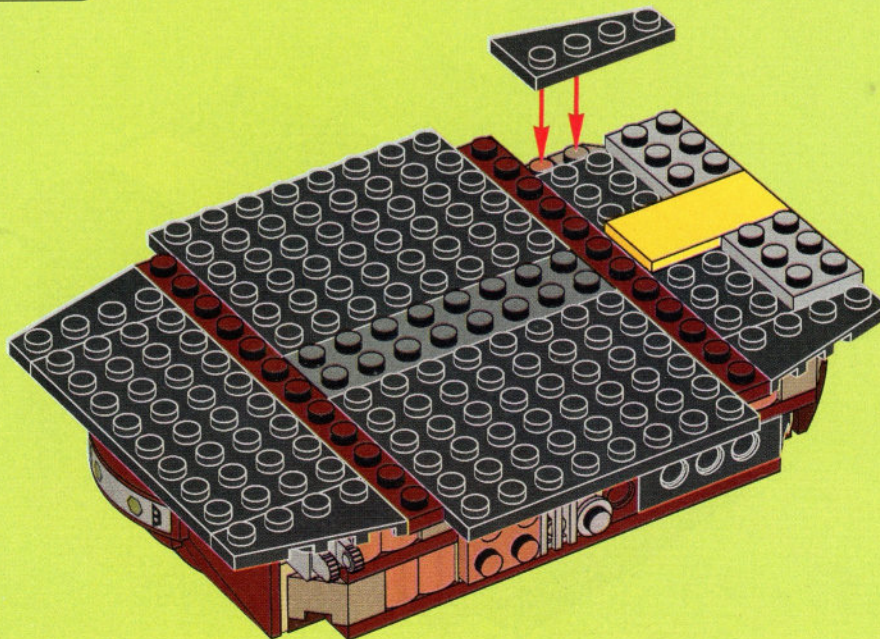

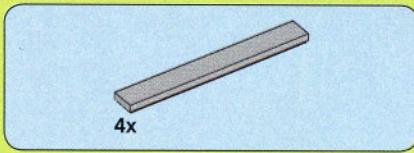

23

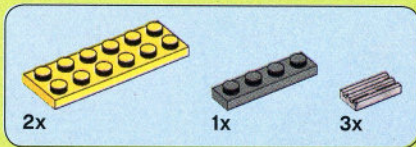
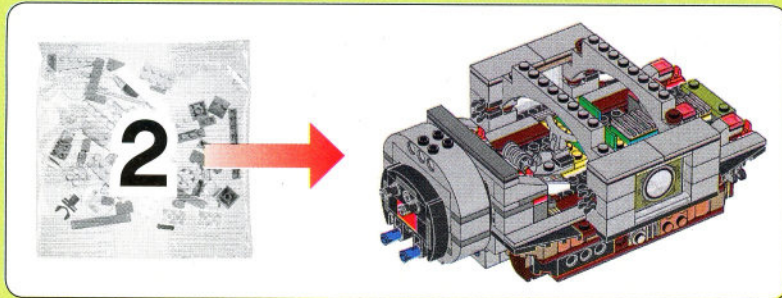
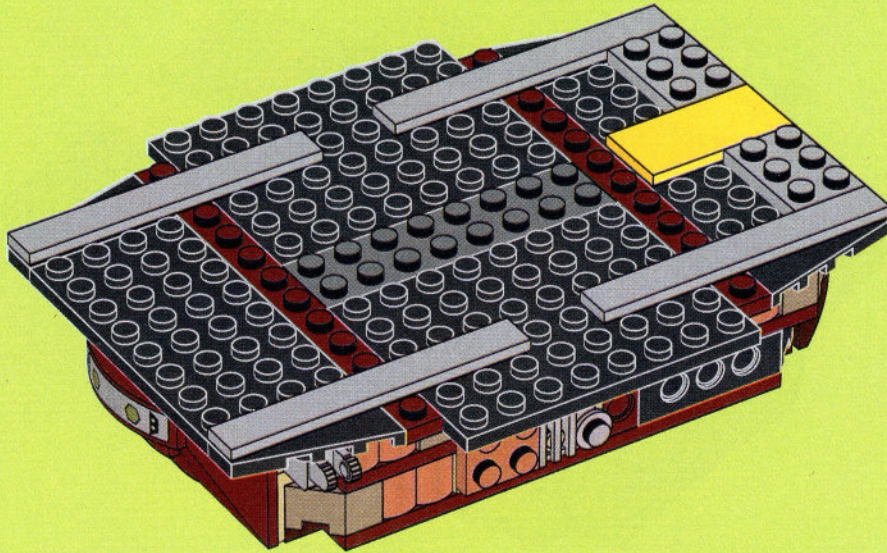

24

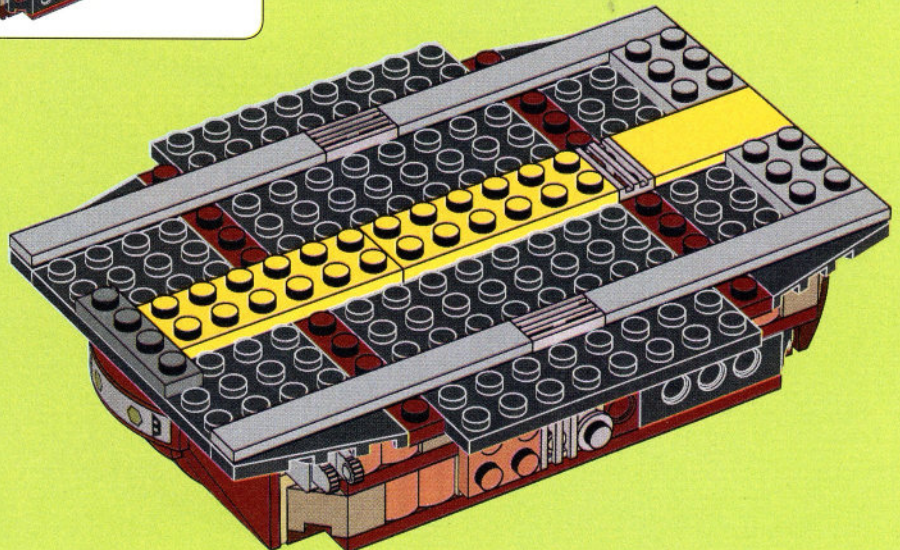

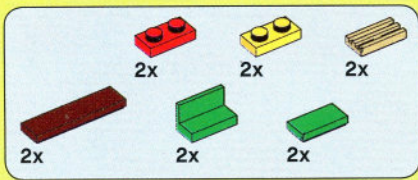

25

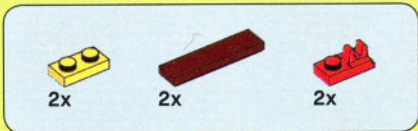
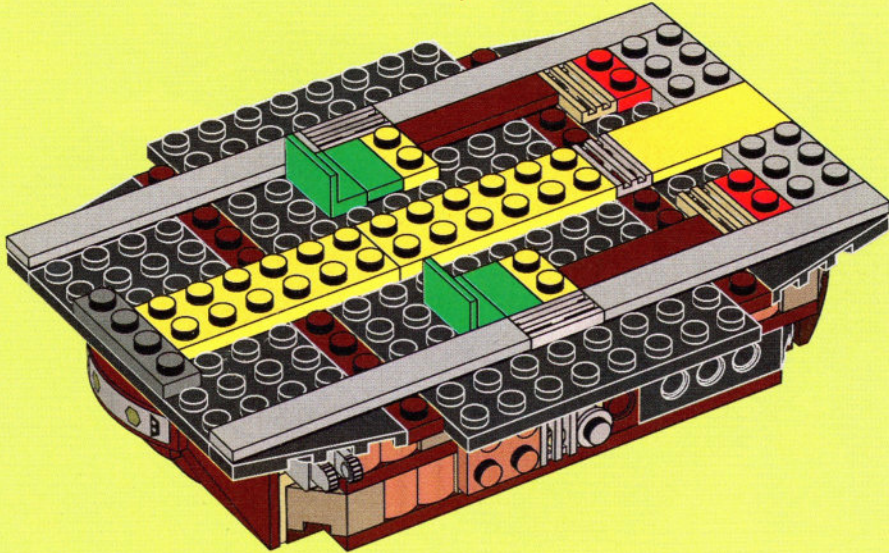

26

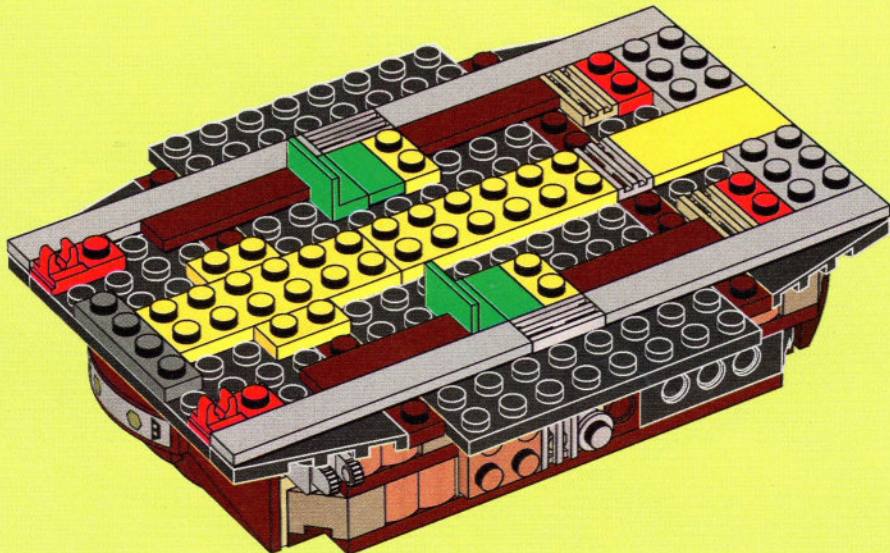

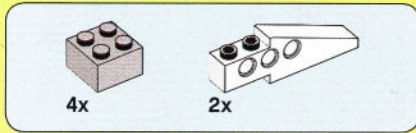

27

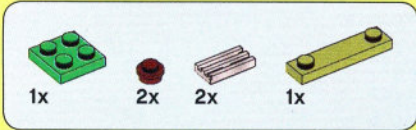
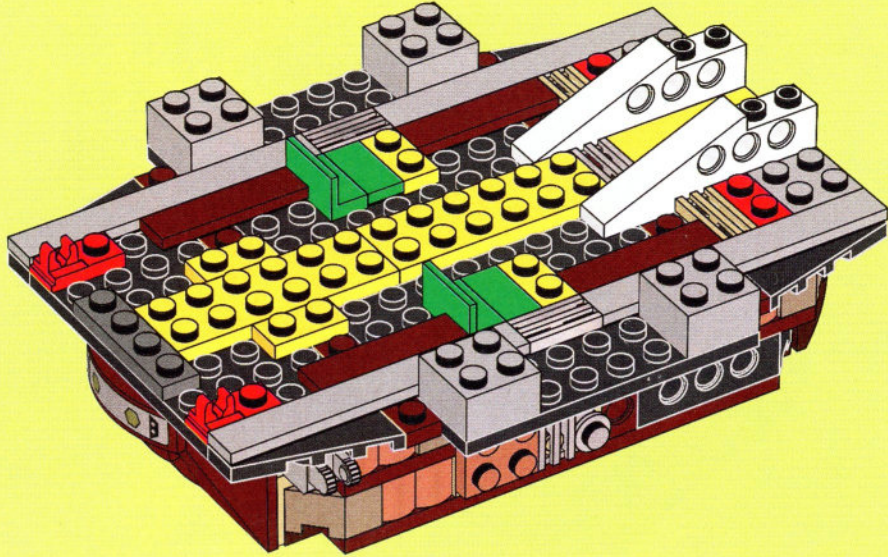

28

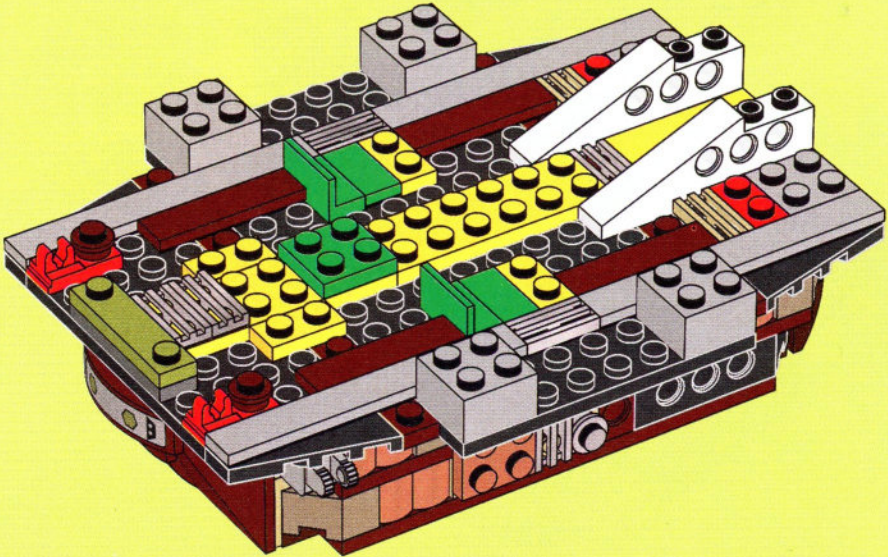

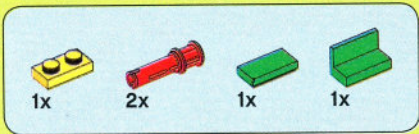

29

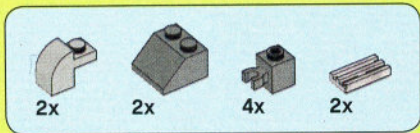
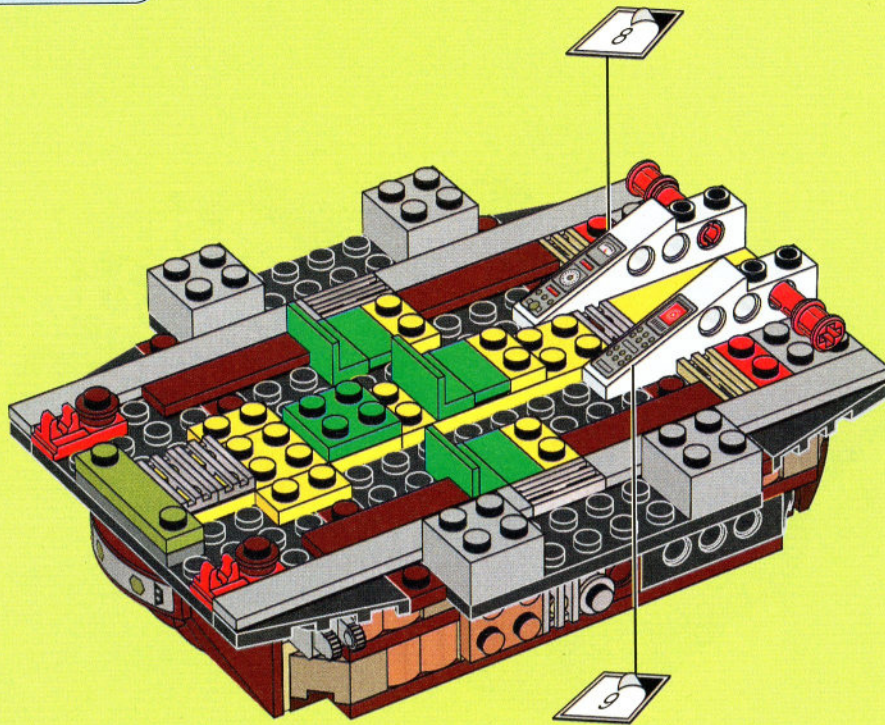

30

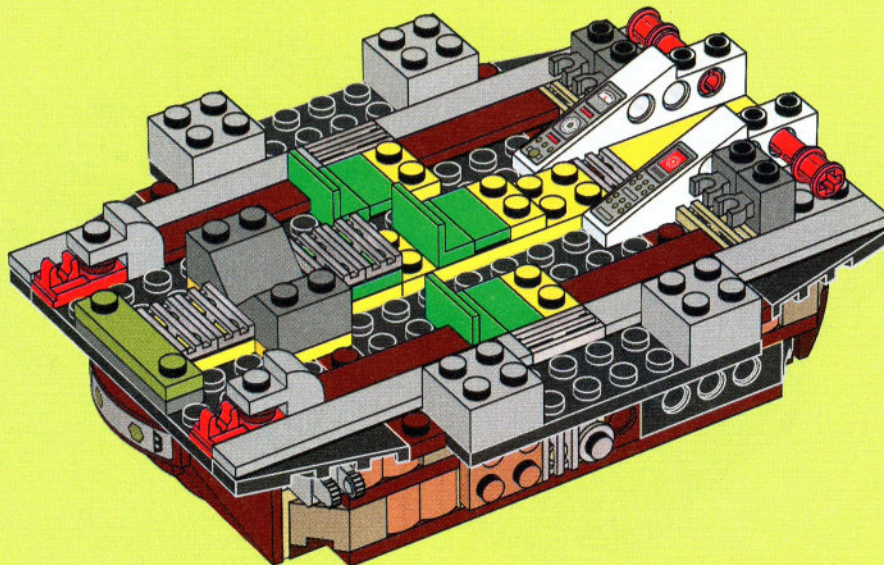

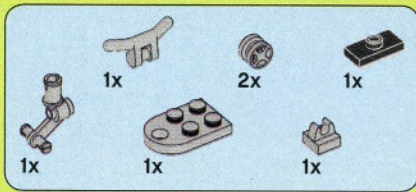

31

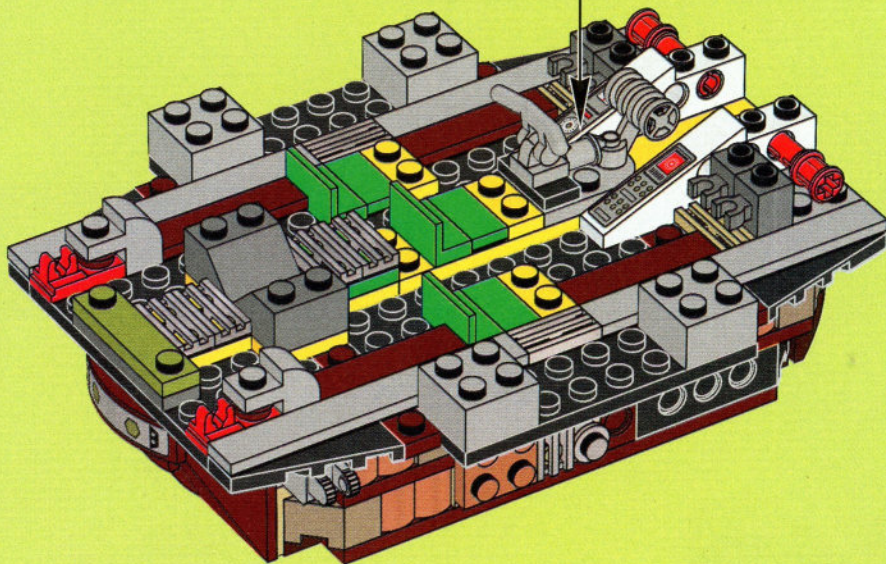
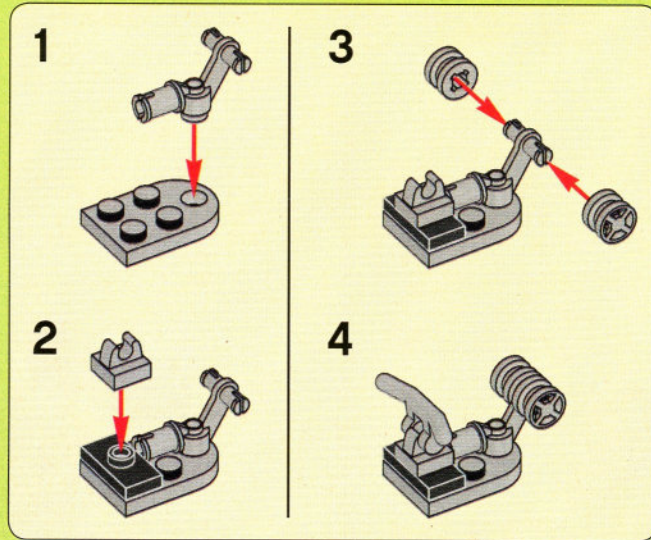

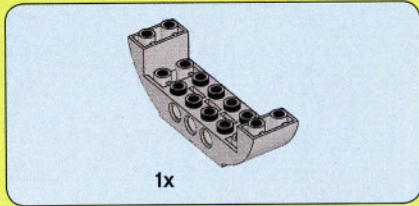
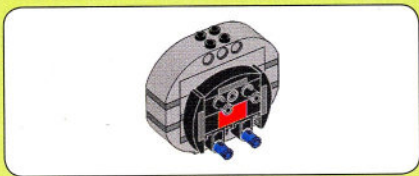

1

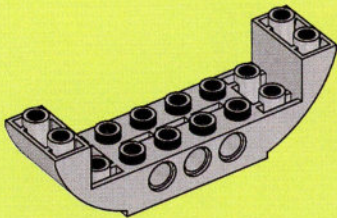

2

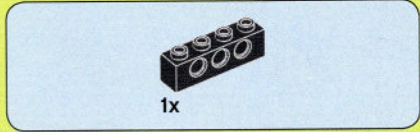
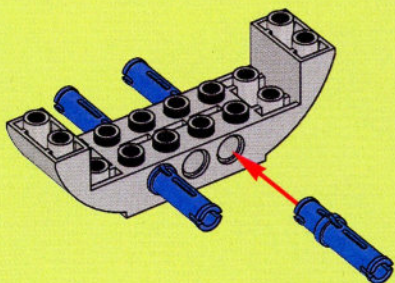

3

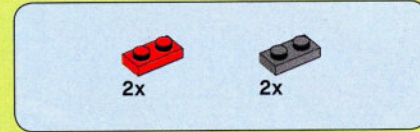
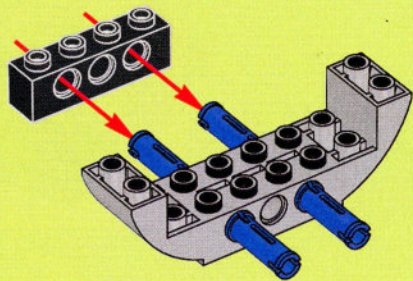

4

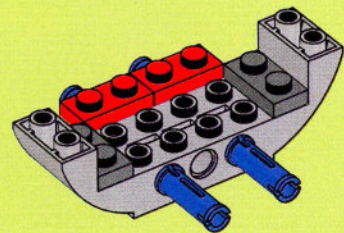

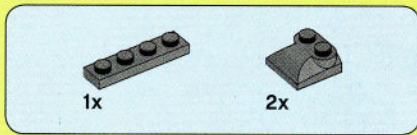

5

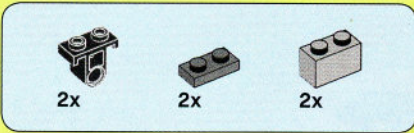
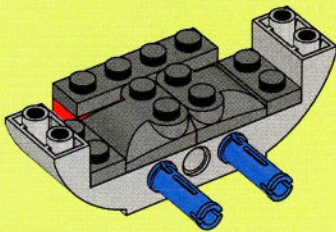

6

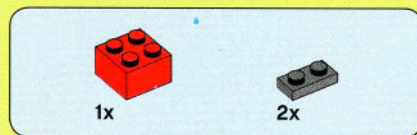
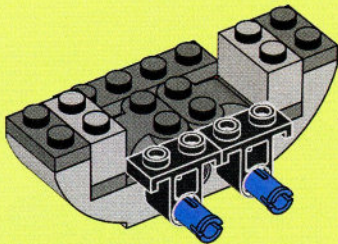

7

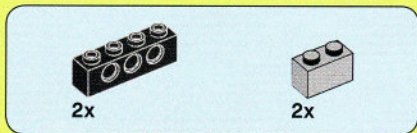
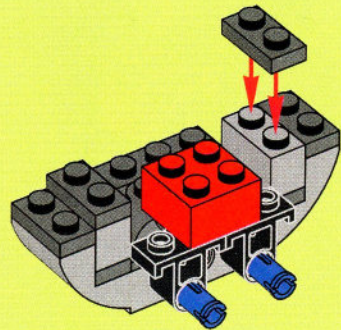

8

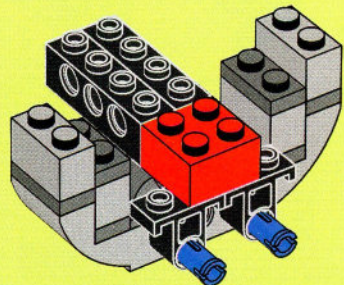



4x

9

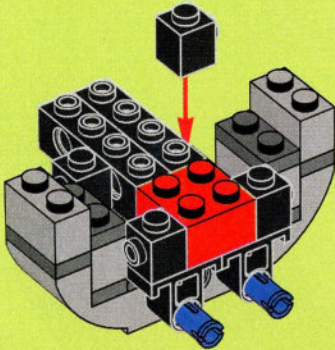

2x



2x

11

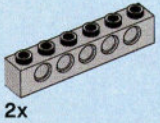
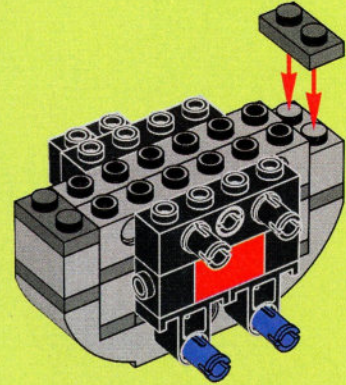

2x



2x

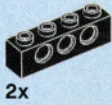

2x

10

1

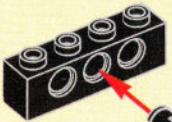

2

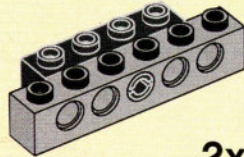

2x

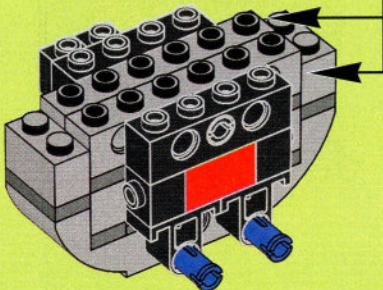

6x



6x

12



6x

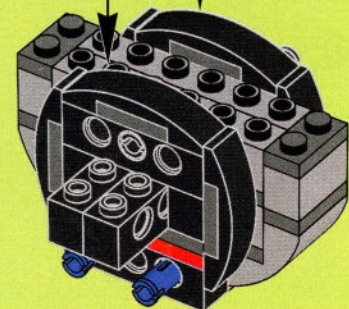

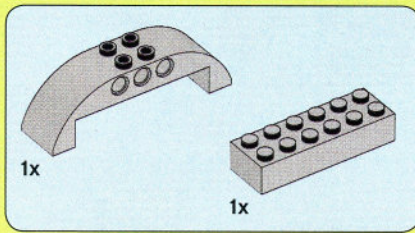

13

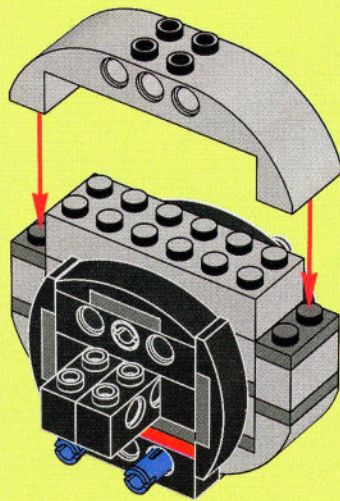

32

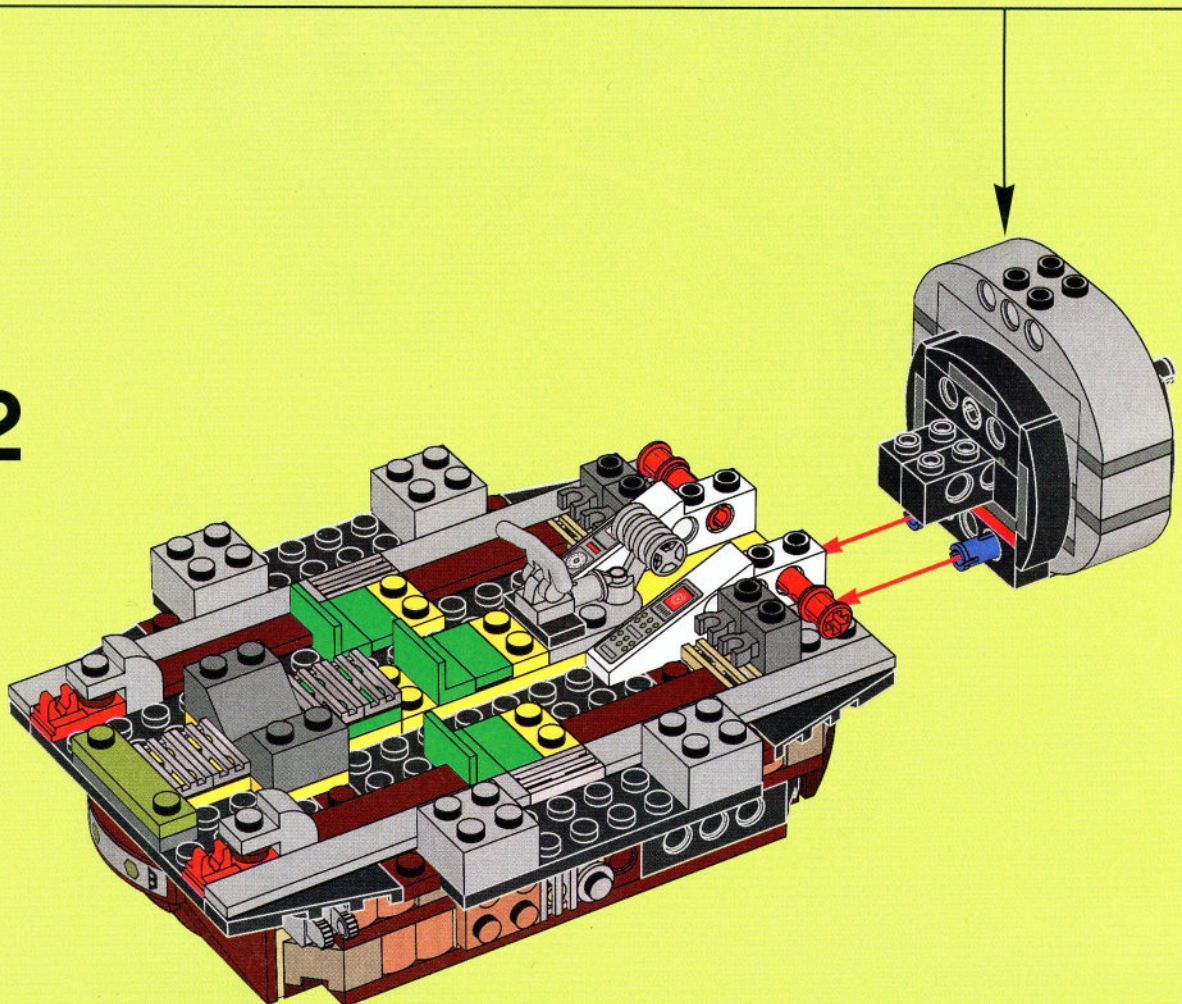

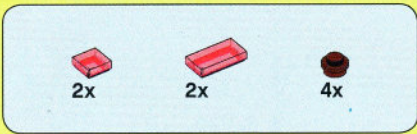

33

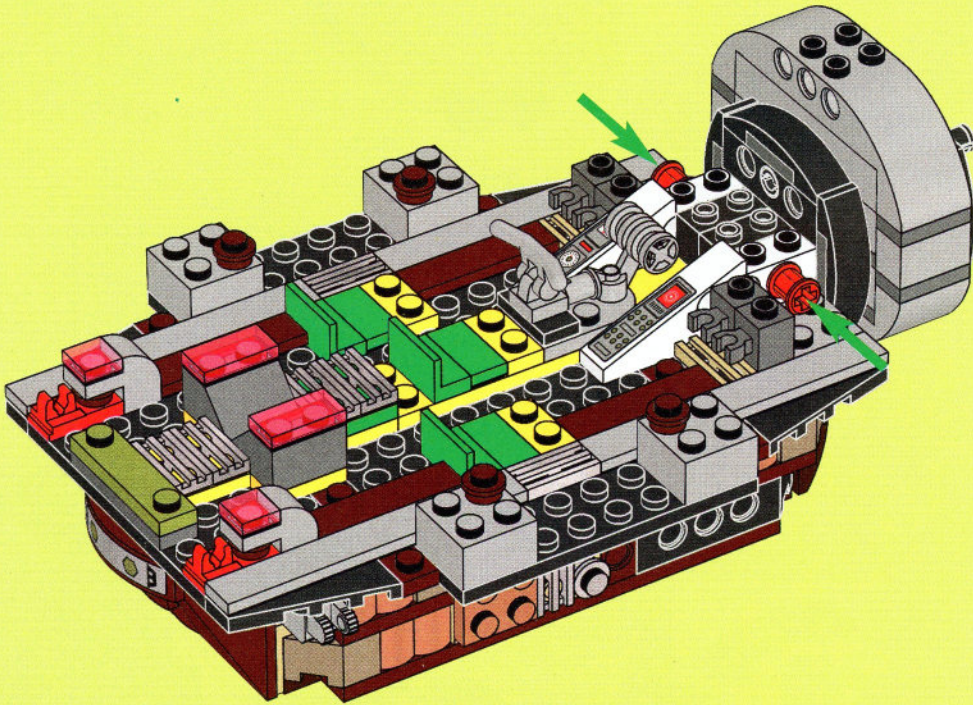



6x

34

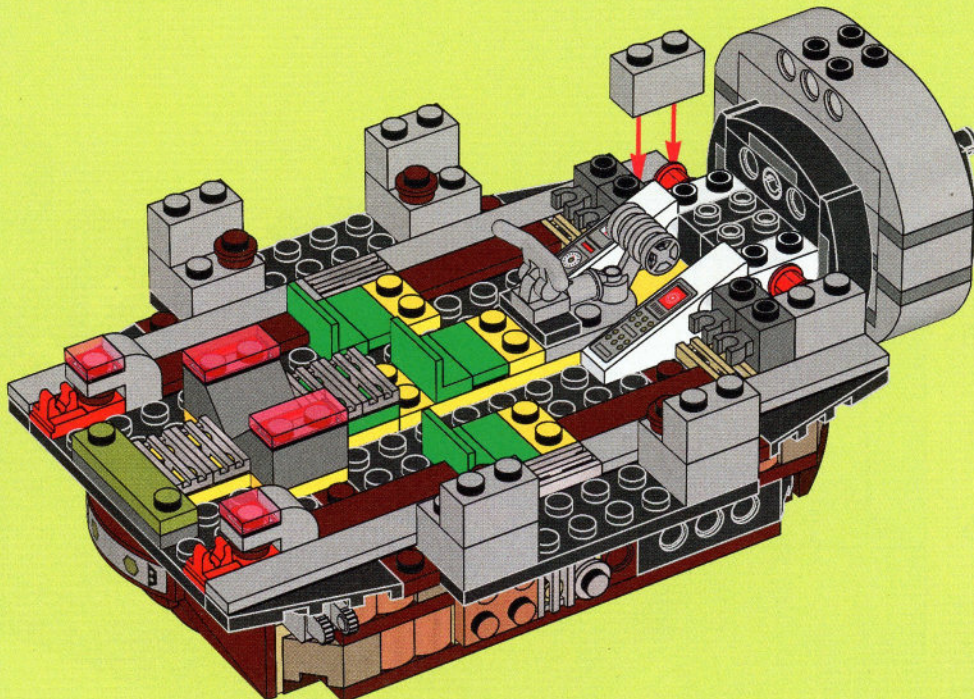

4x



8x

35

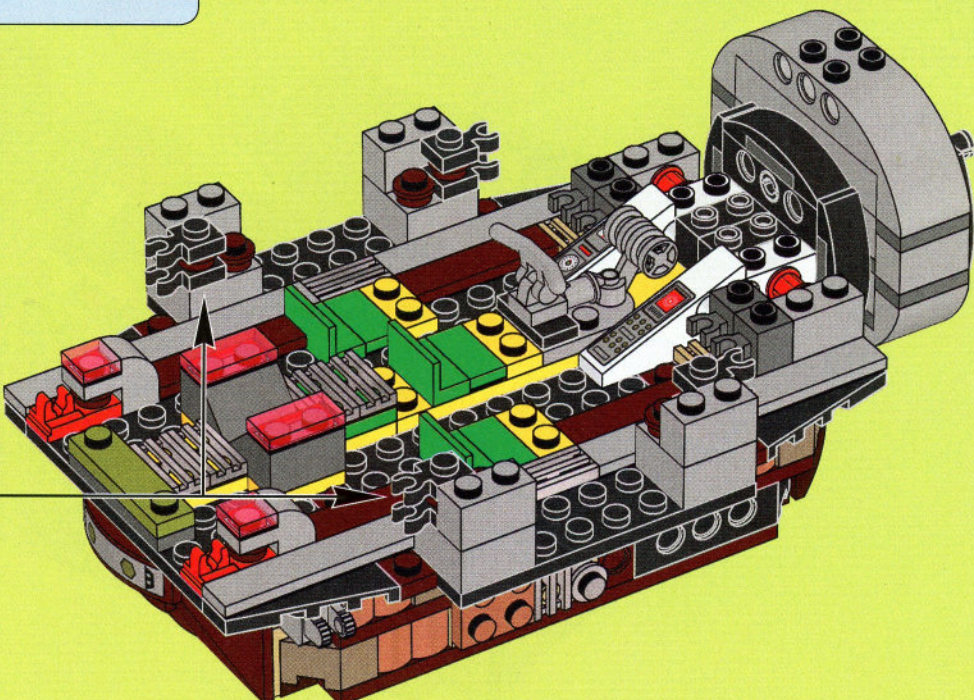

4x

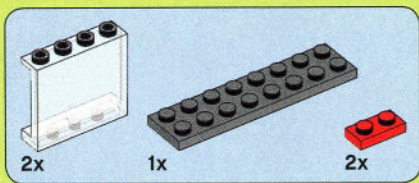

36

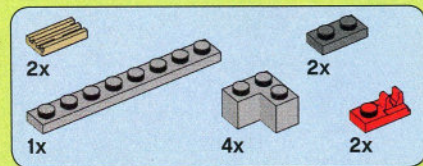
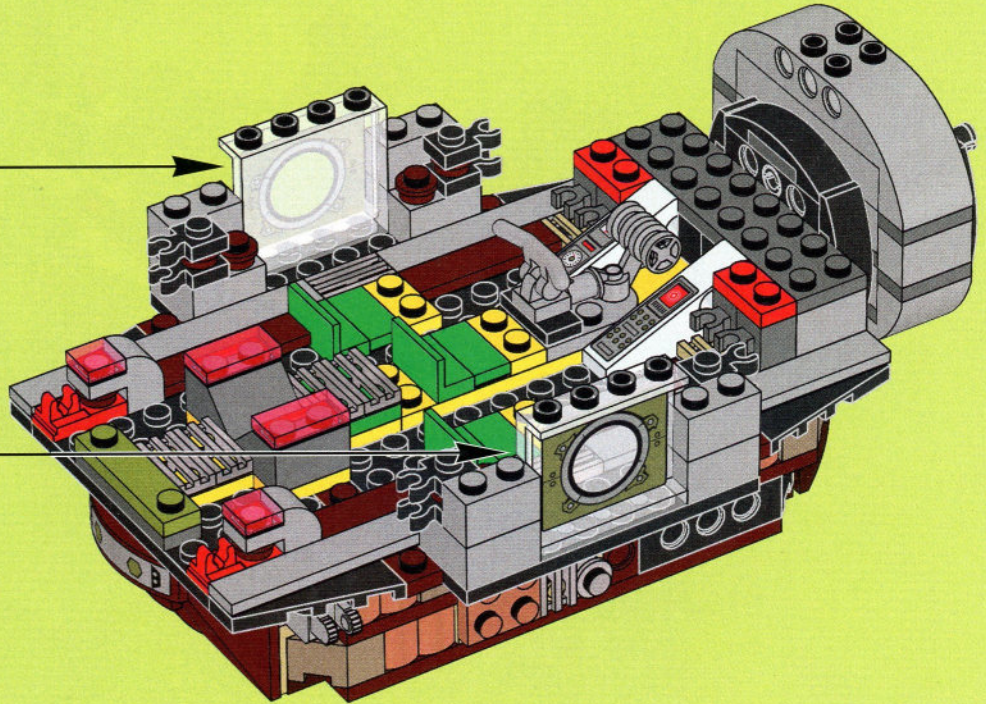
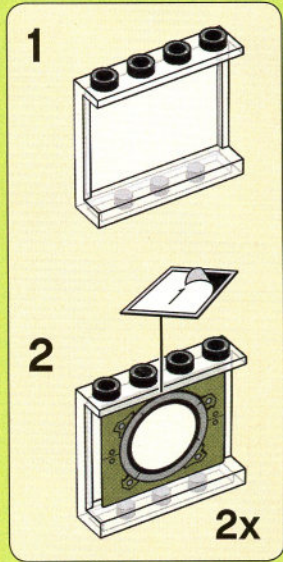

37

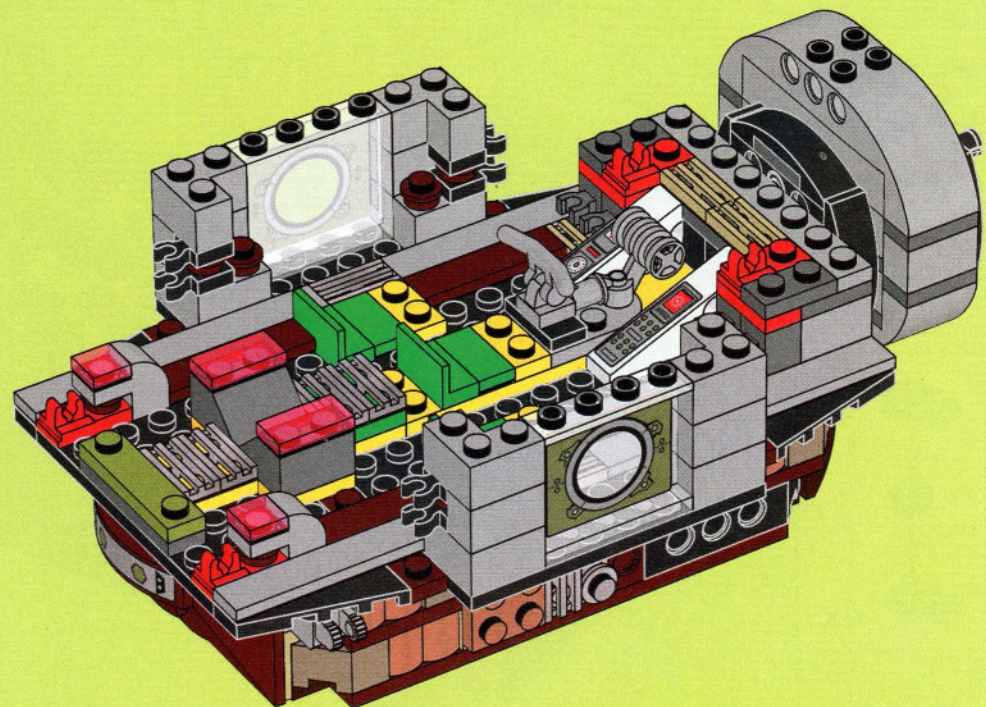

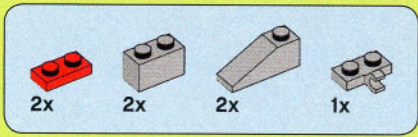

38

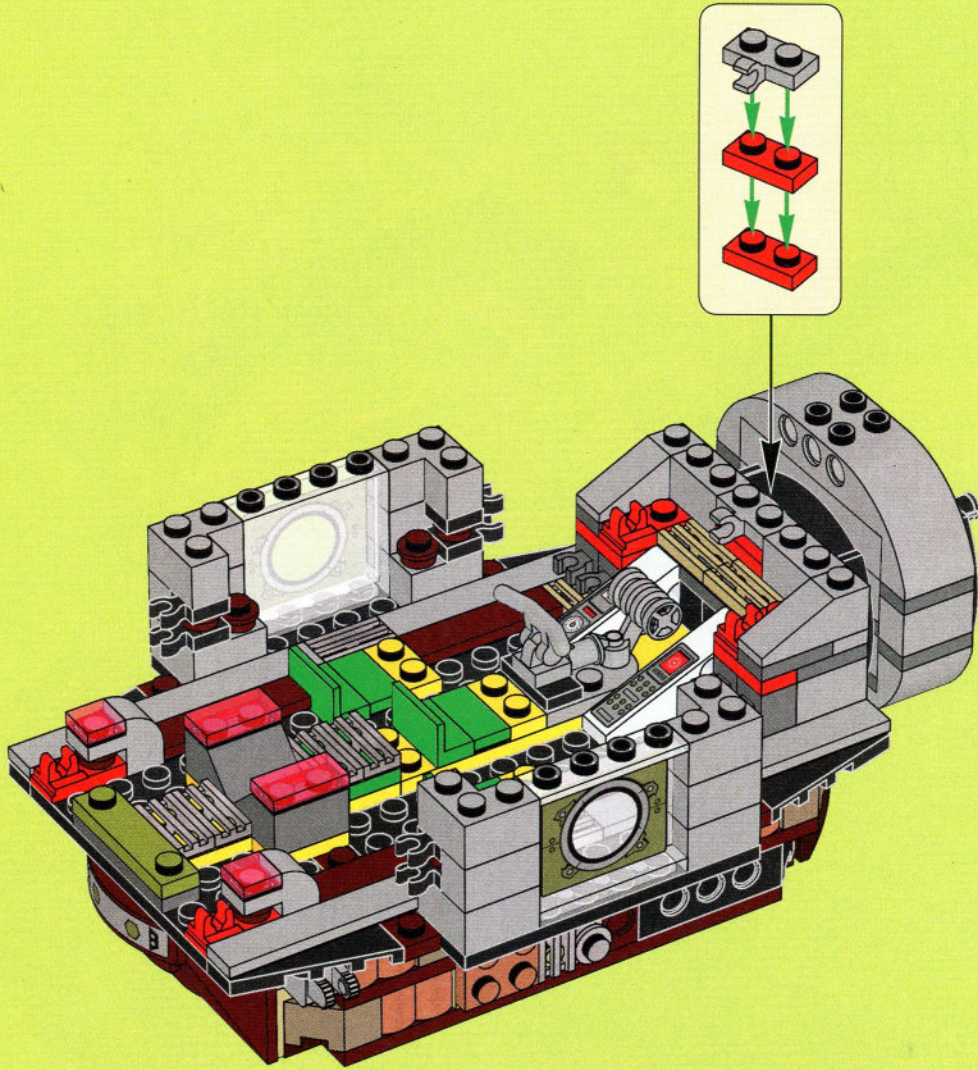

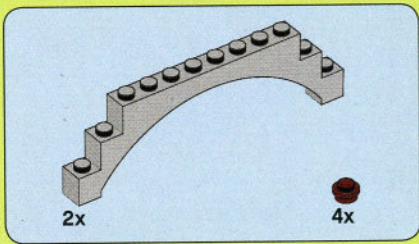

39

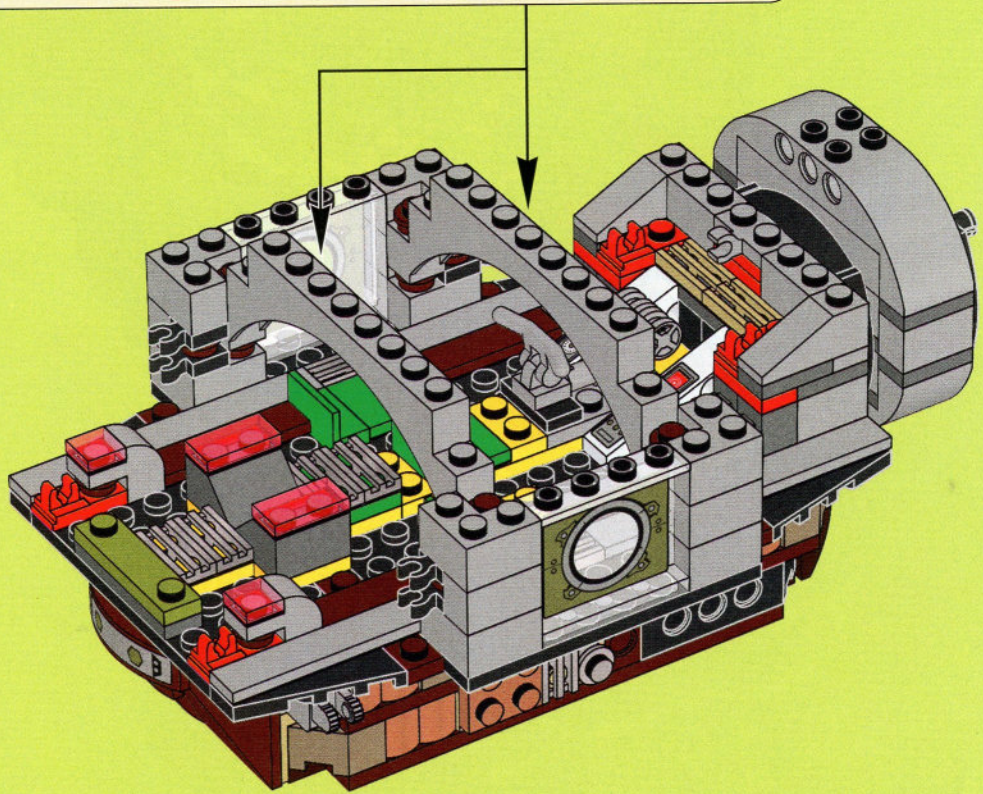
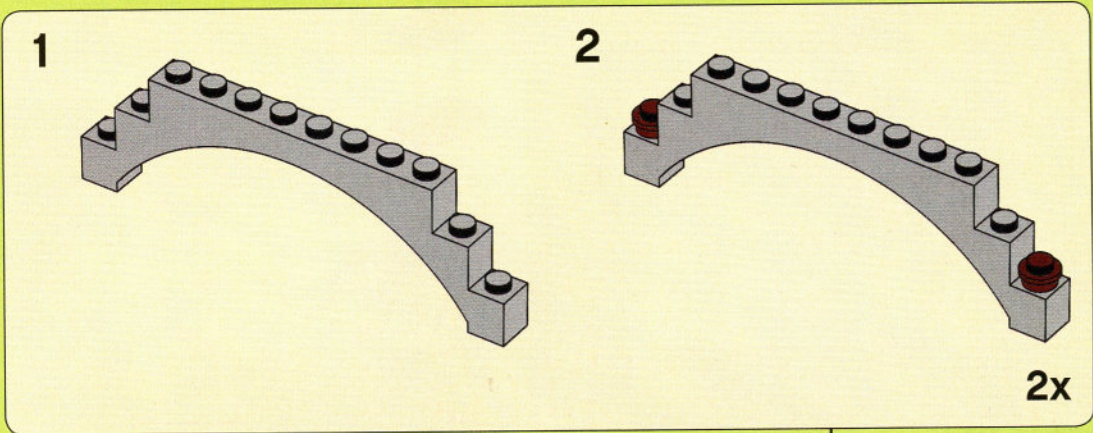

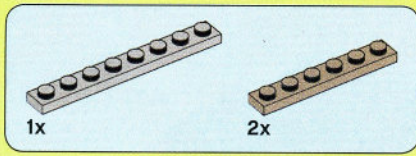

40

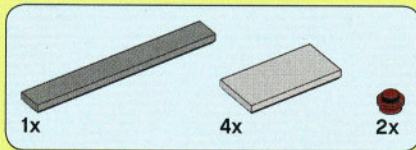
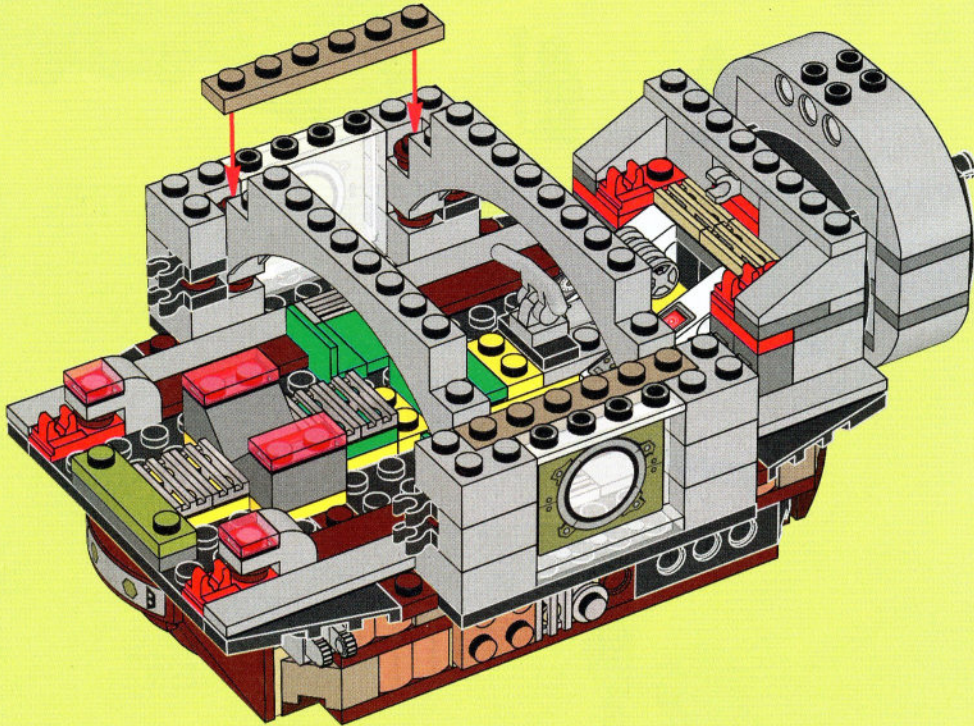

41

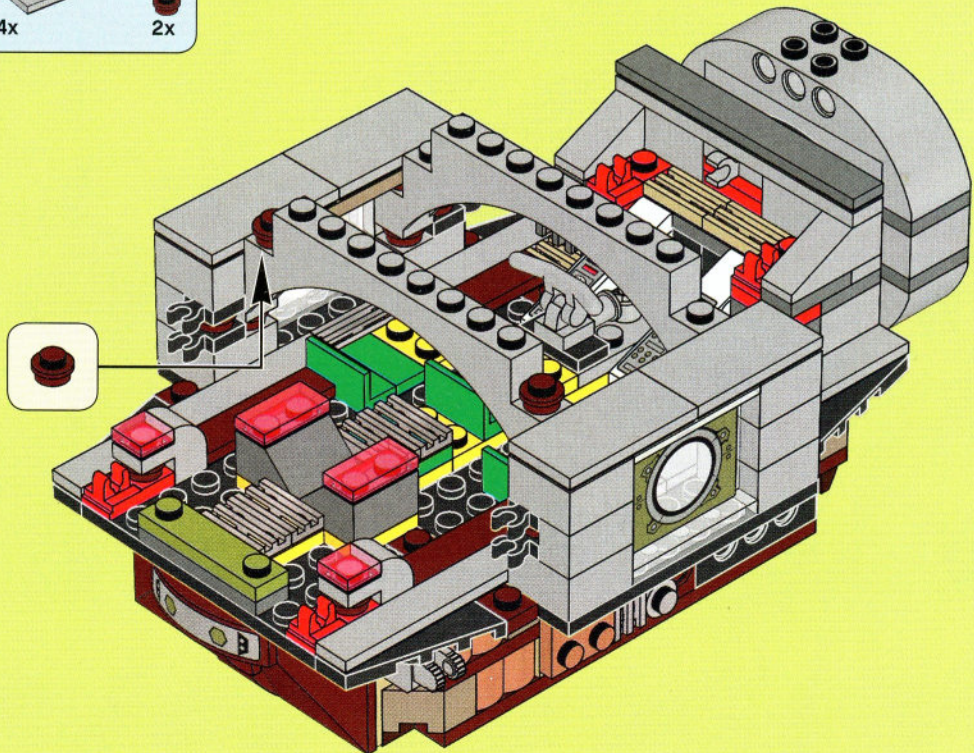



3

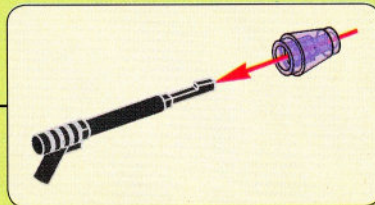
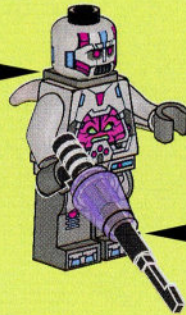
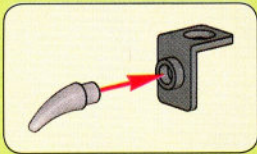
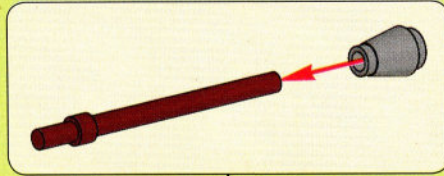
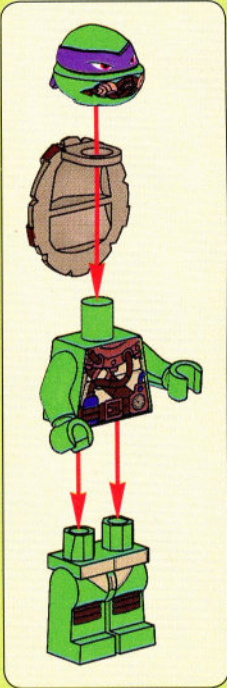
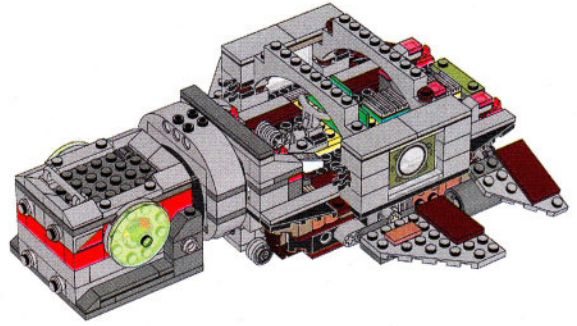

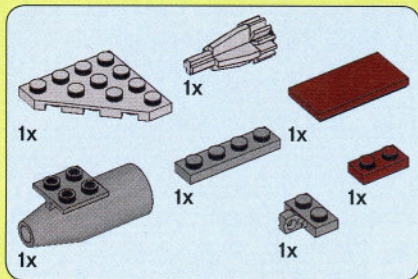

42

1

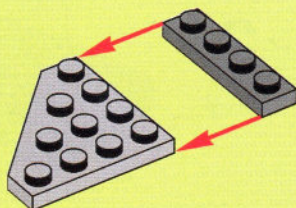

2

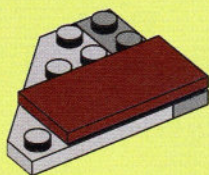

3

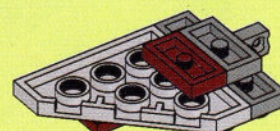

4

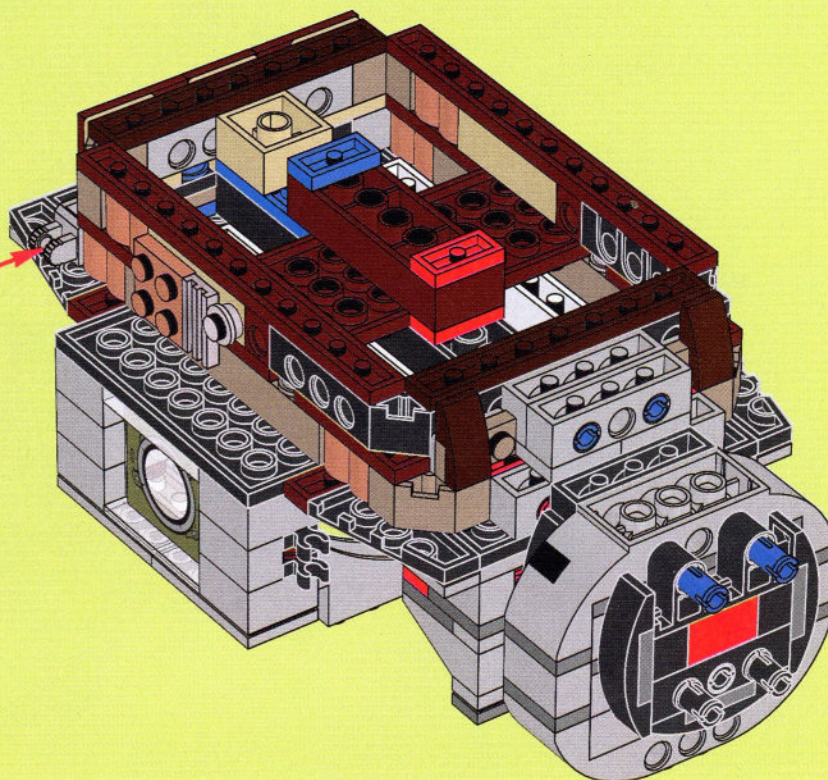
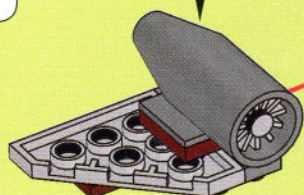
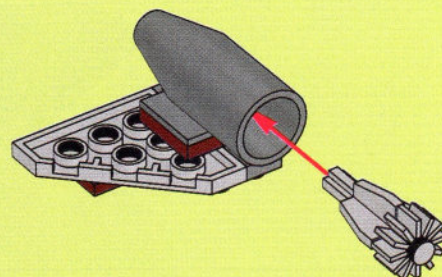

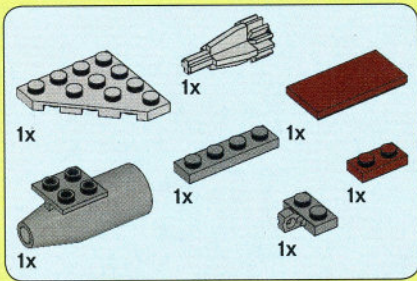

43

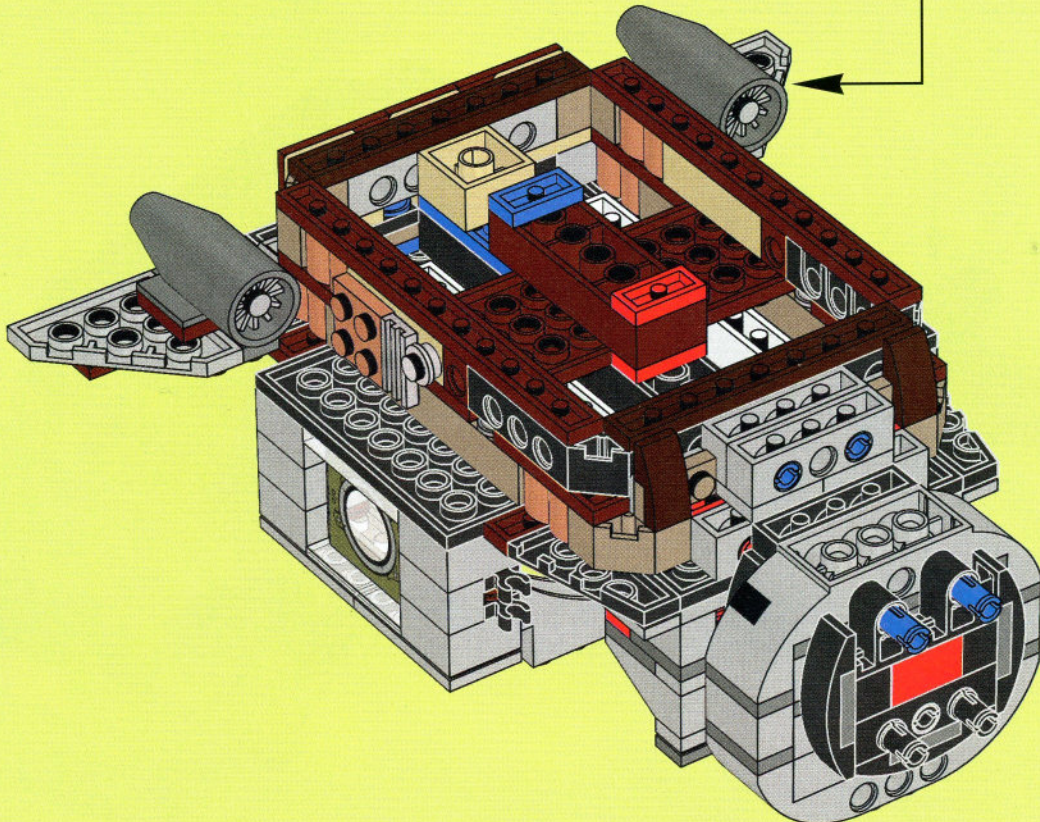
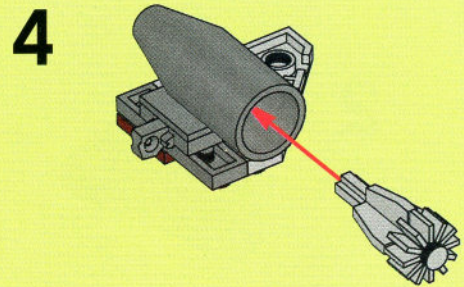
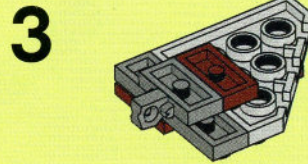
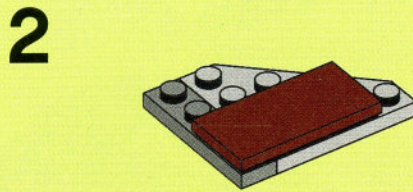
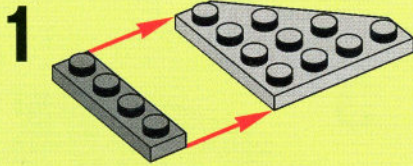

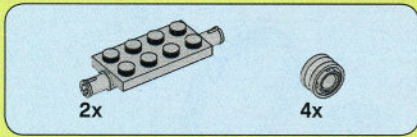

44

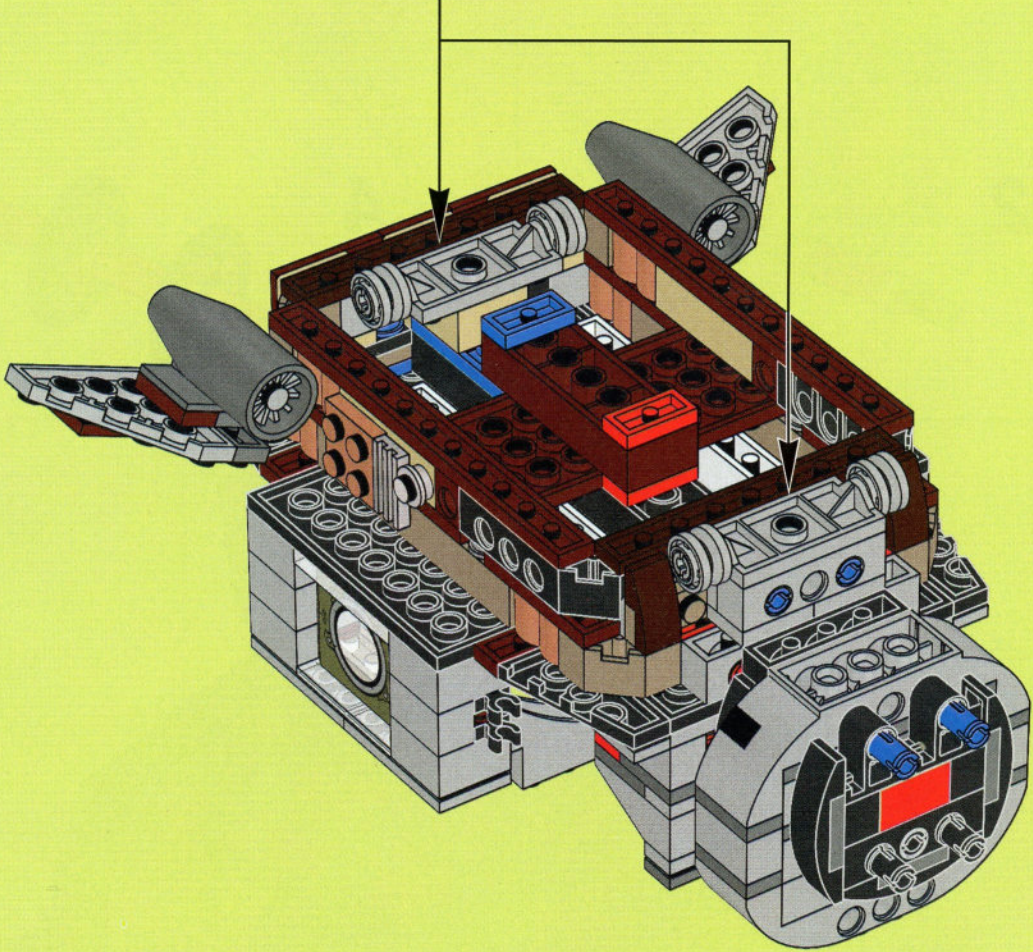
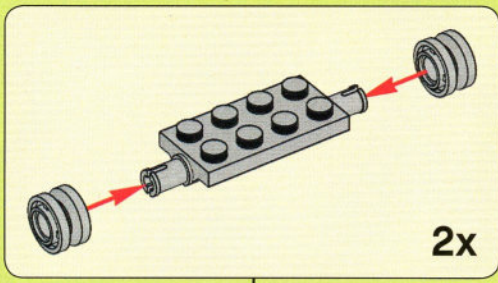

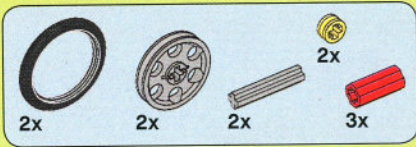

45

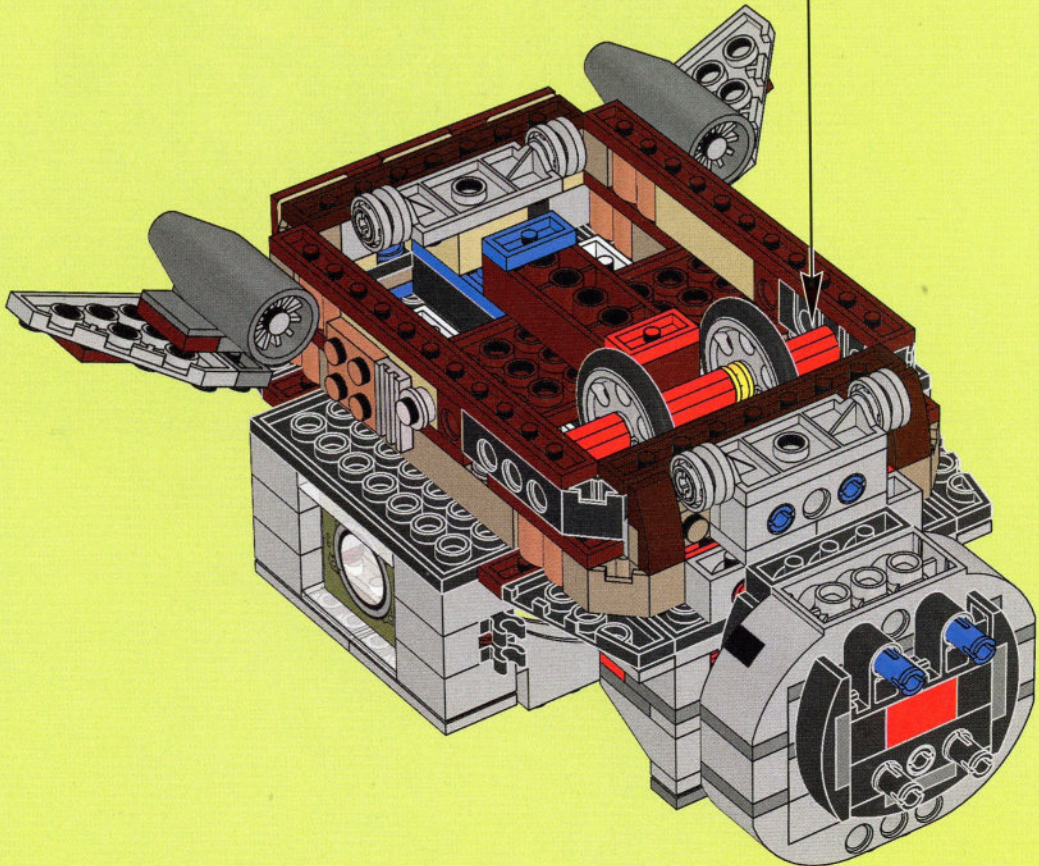
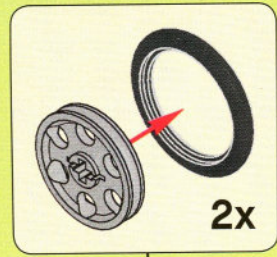
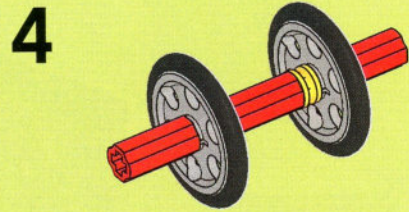
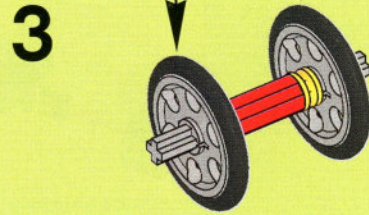
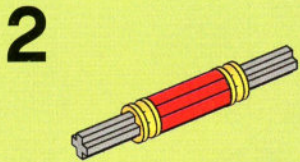
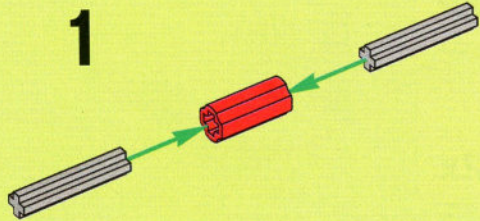

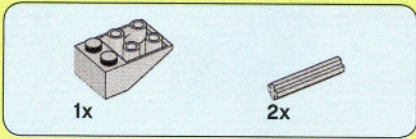

46

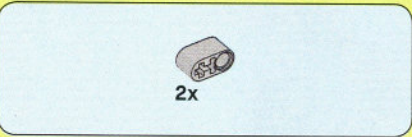
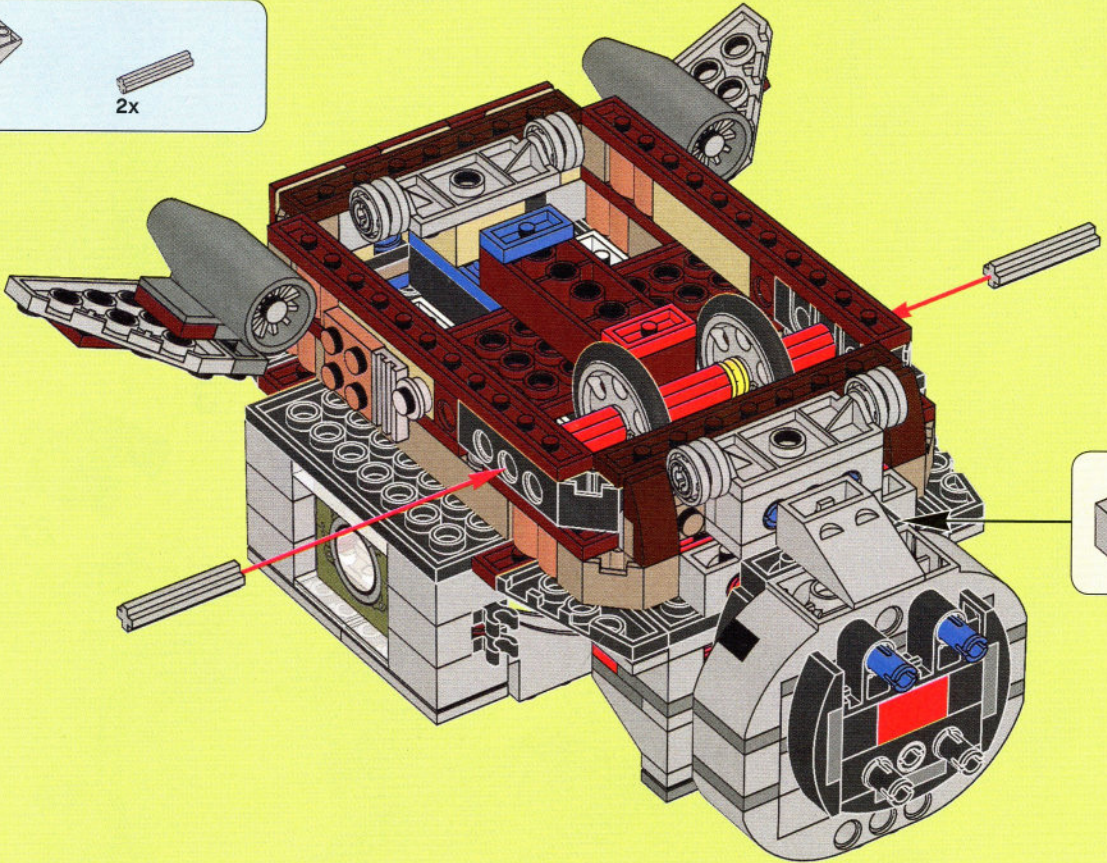

47

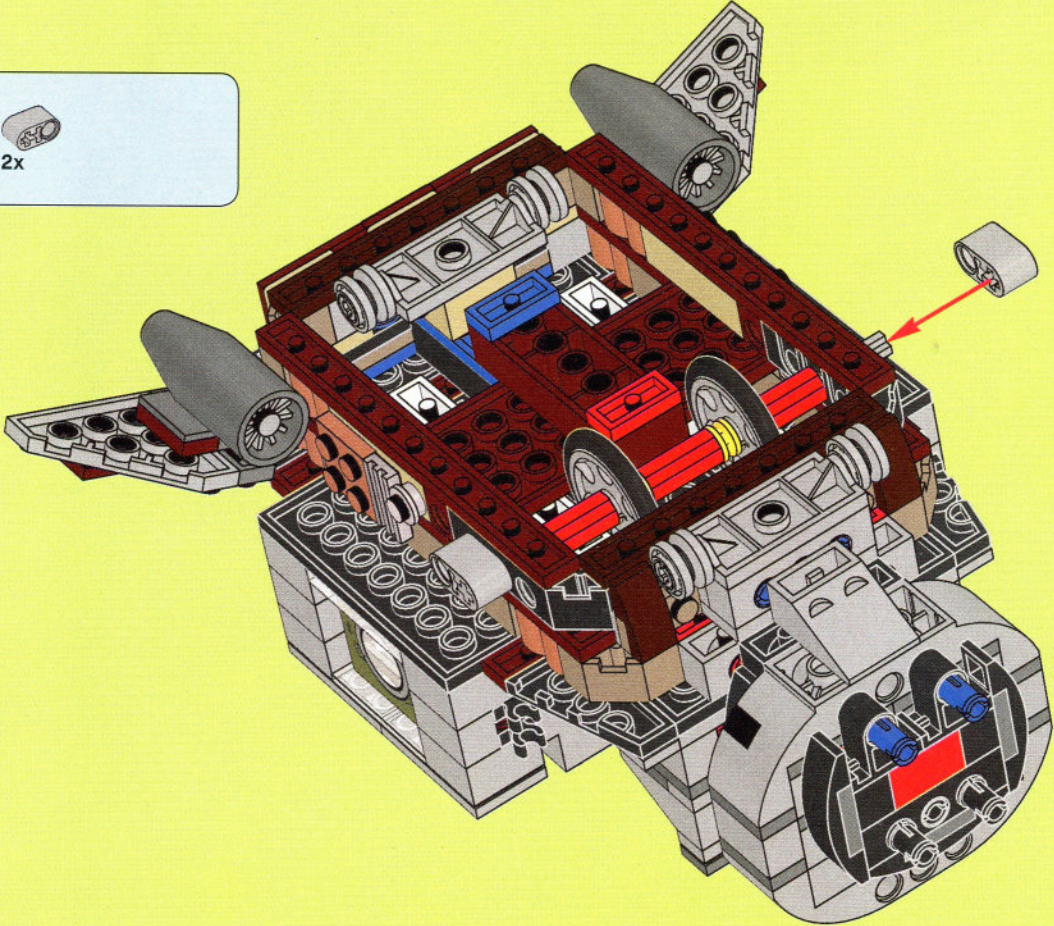

4x



2x



2x



4x

48

1

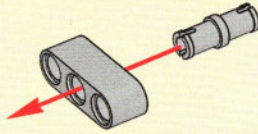

2

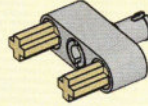

3

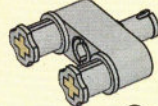

2x

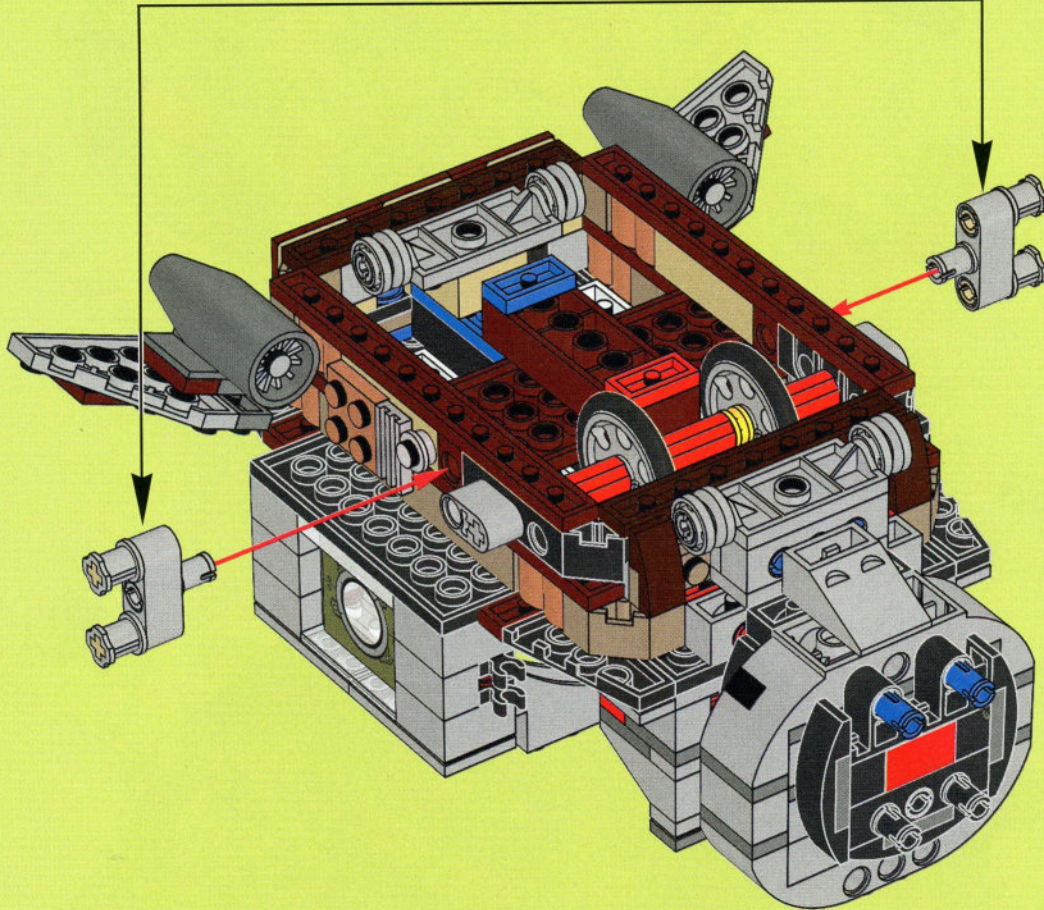

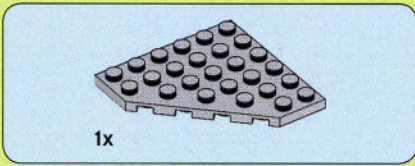

1

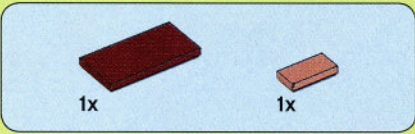
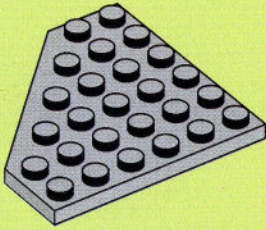

2

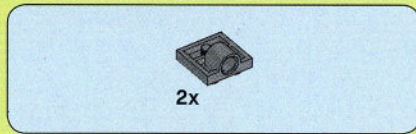
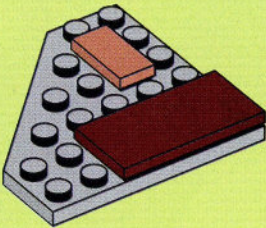

3

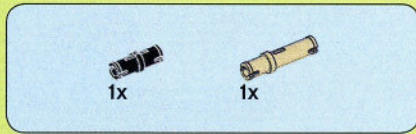
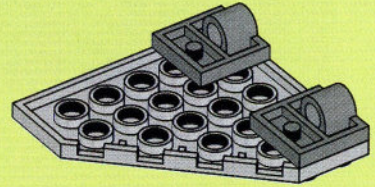

4

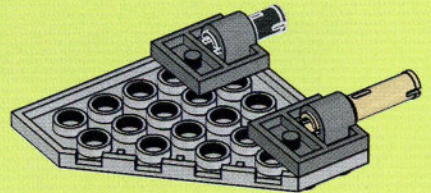

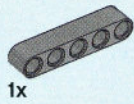

1x

5

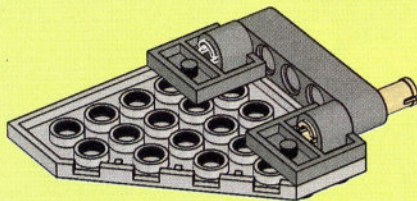

49

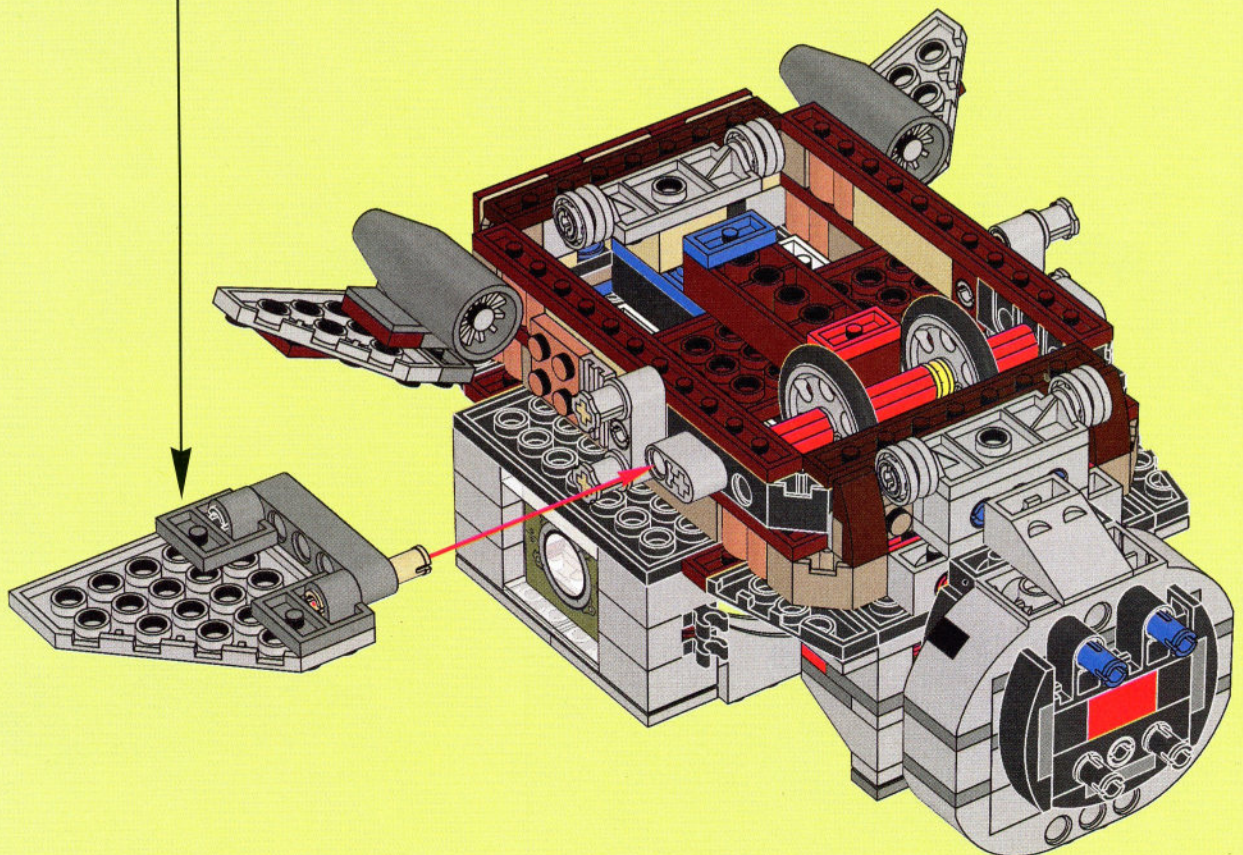



1x

5

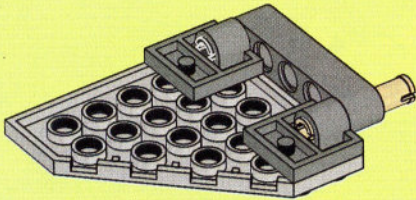

49

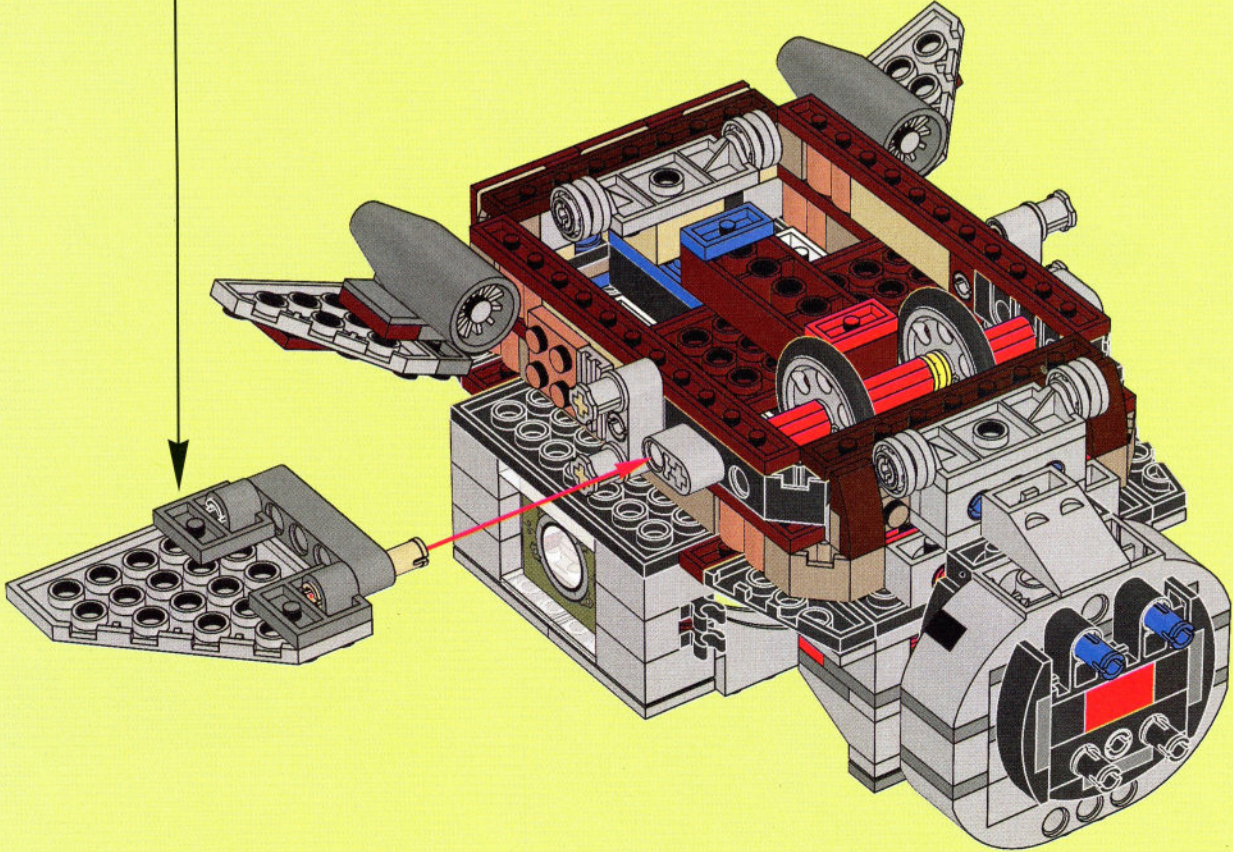

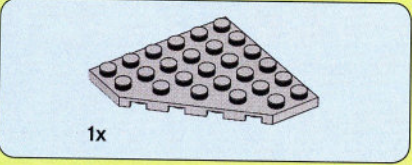
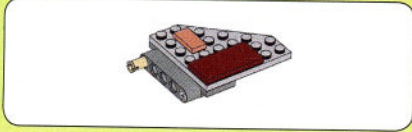

1

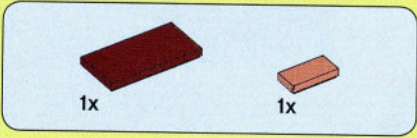
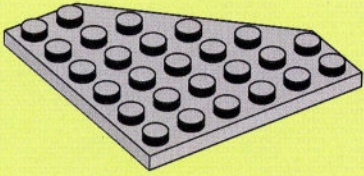

2

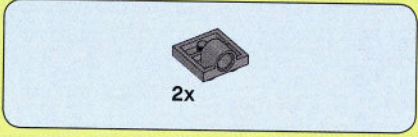
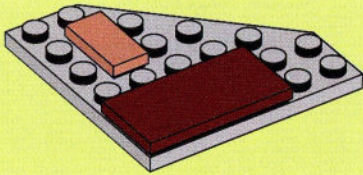

2x

3

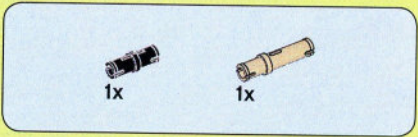
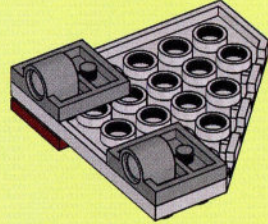

4

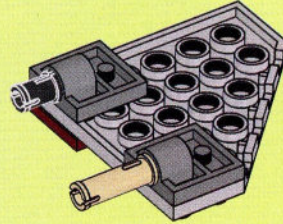

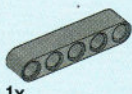

1x

5

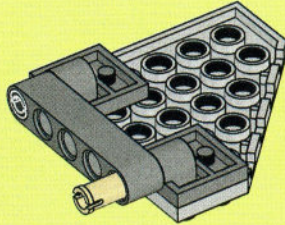

50

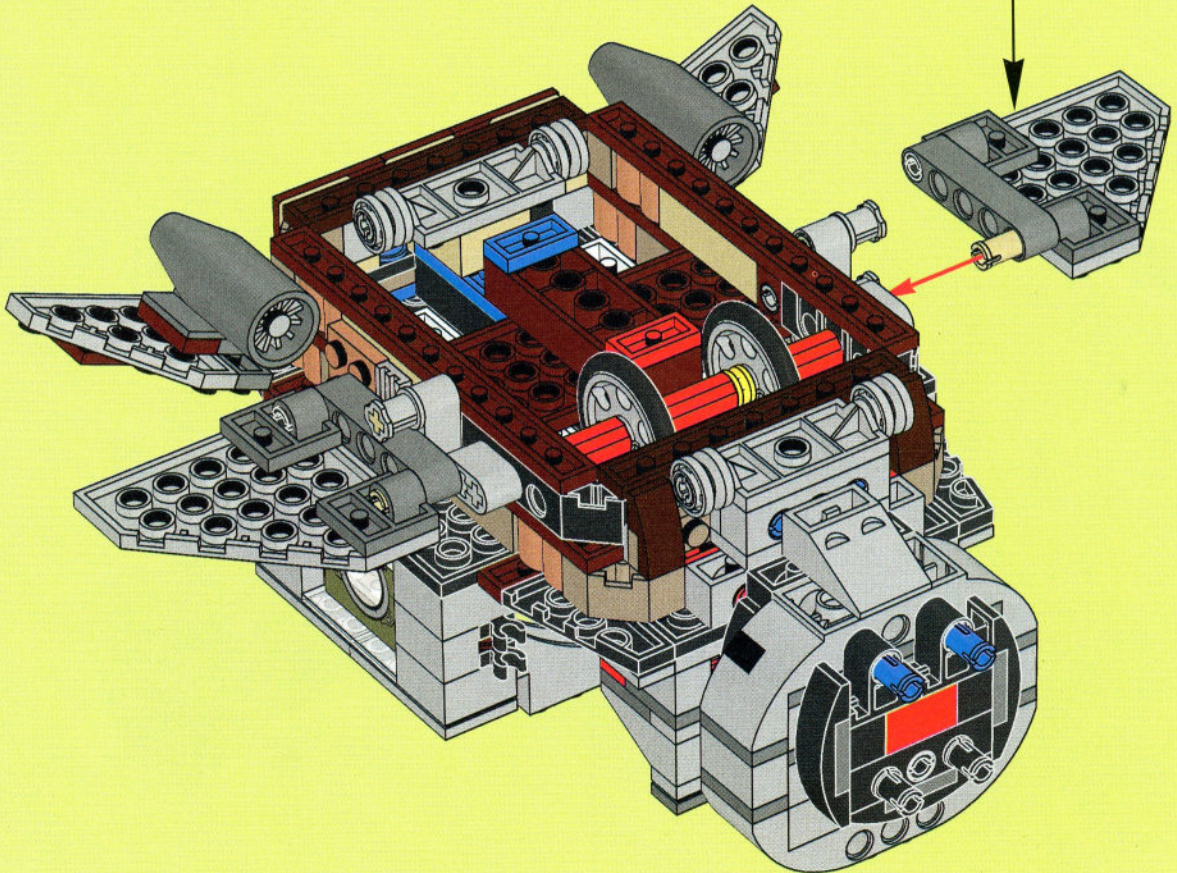

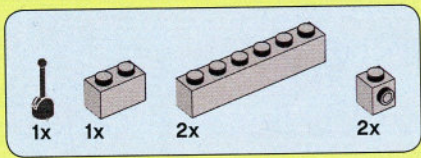

5

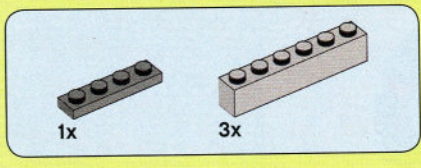
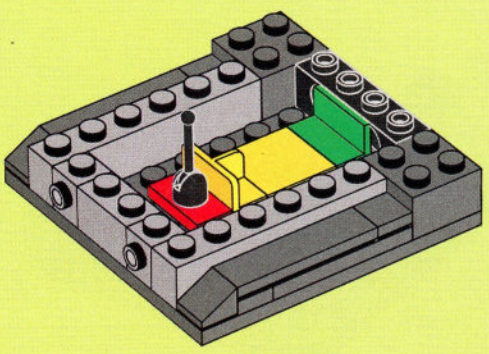

7

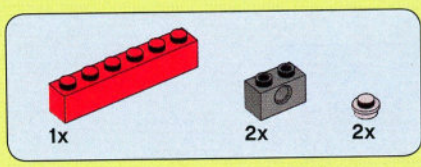
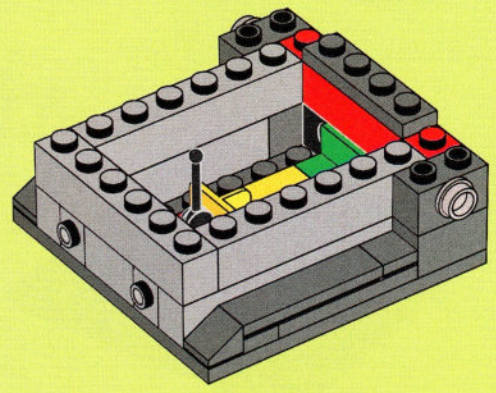

6

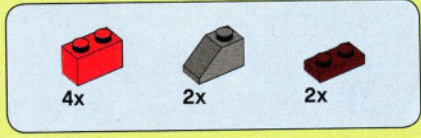
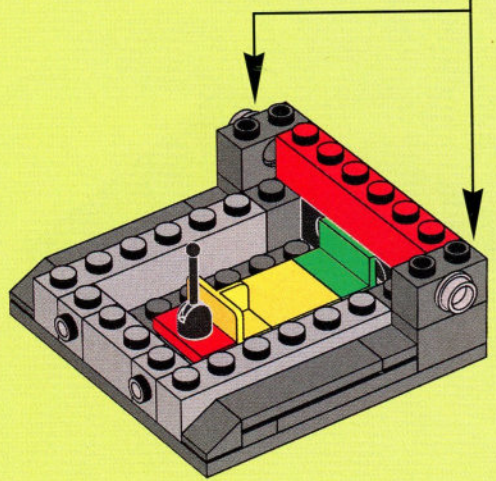
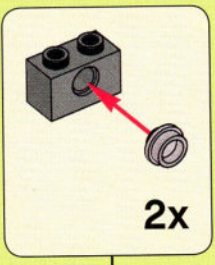

8

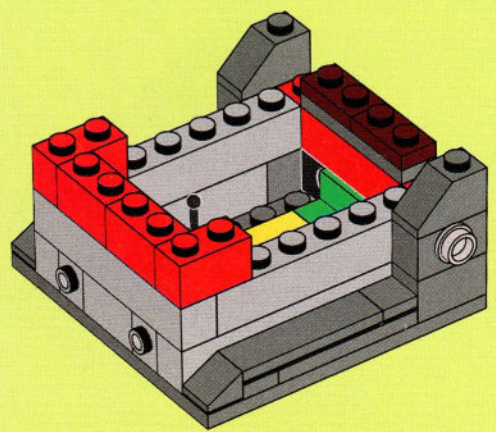

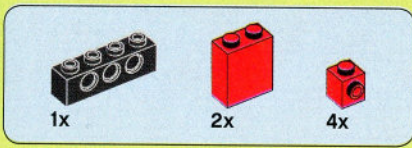

9

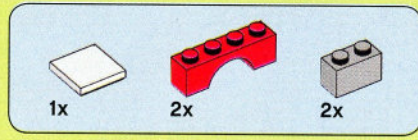
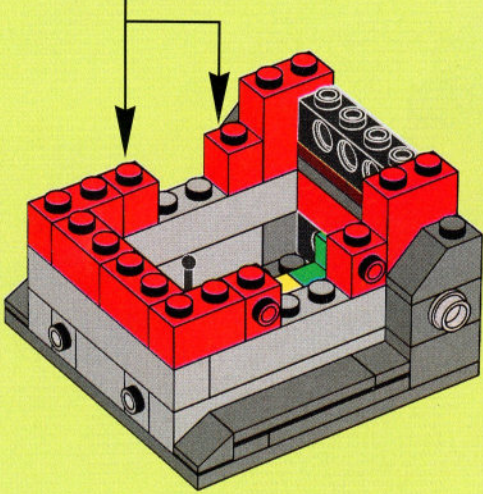
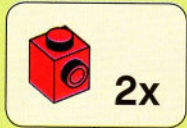

11

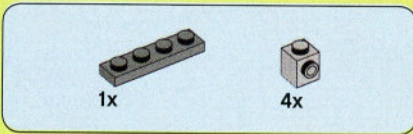
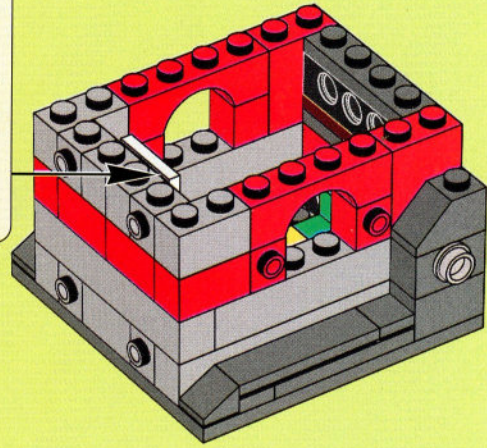
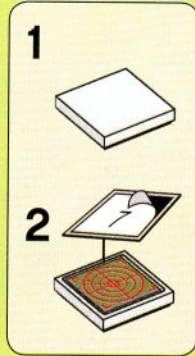

10

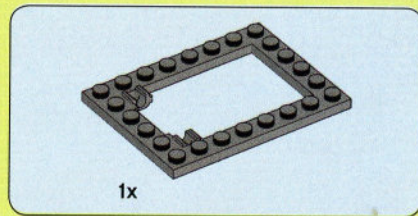
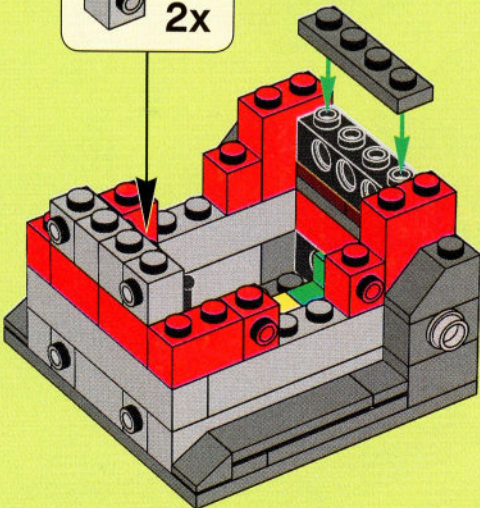
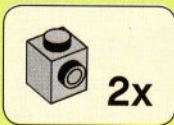

12

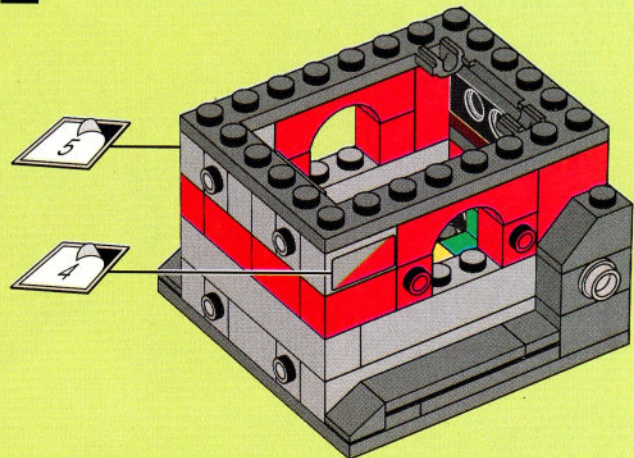



4x



4x

13

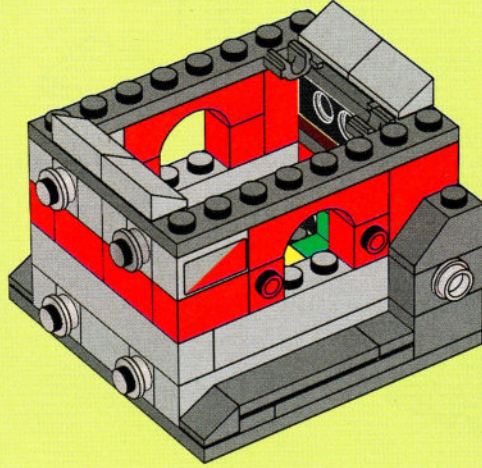

4x



2x

14

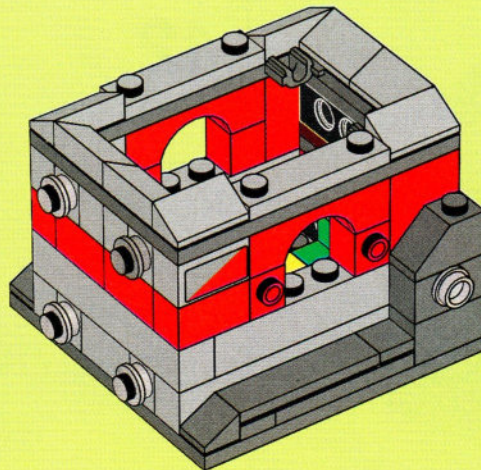

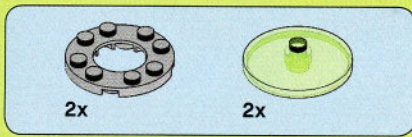

15

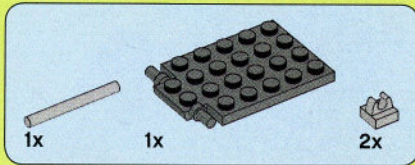
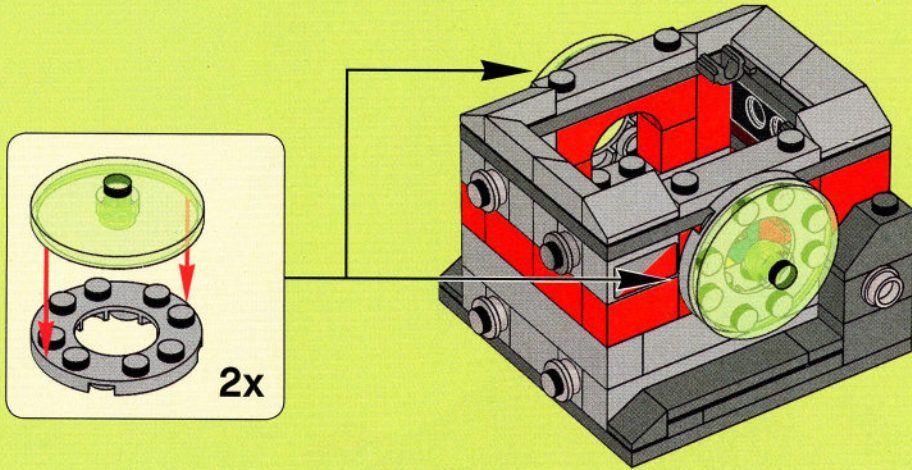

16

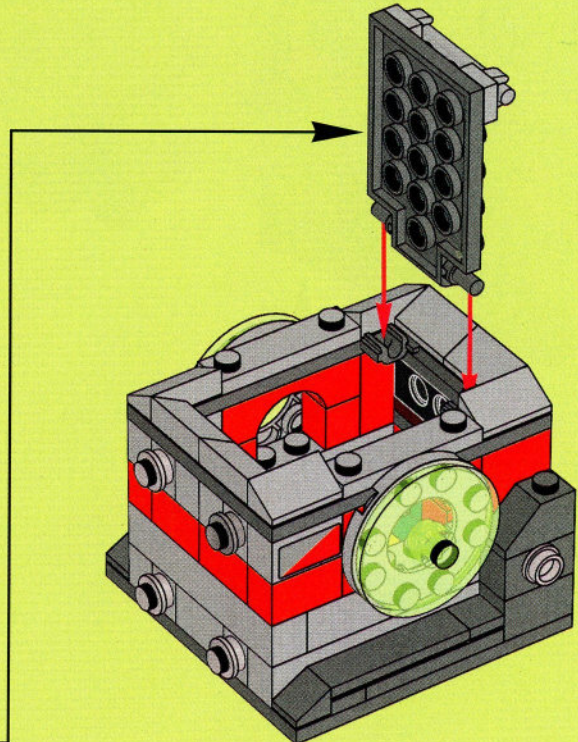
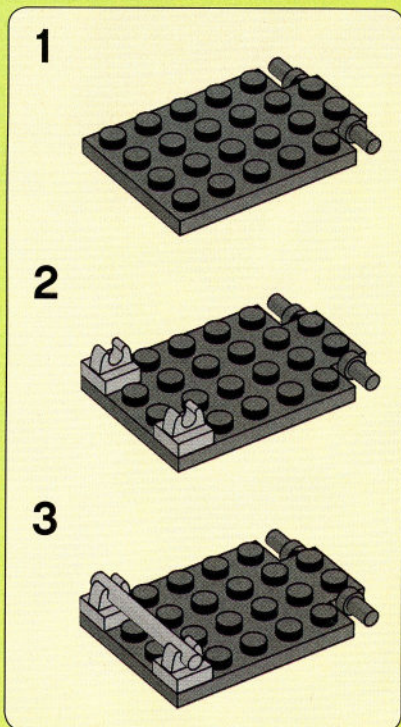

51

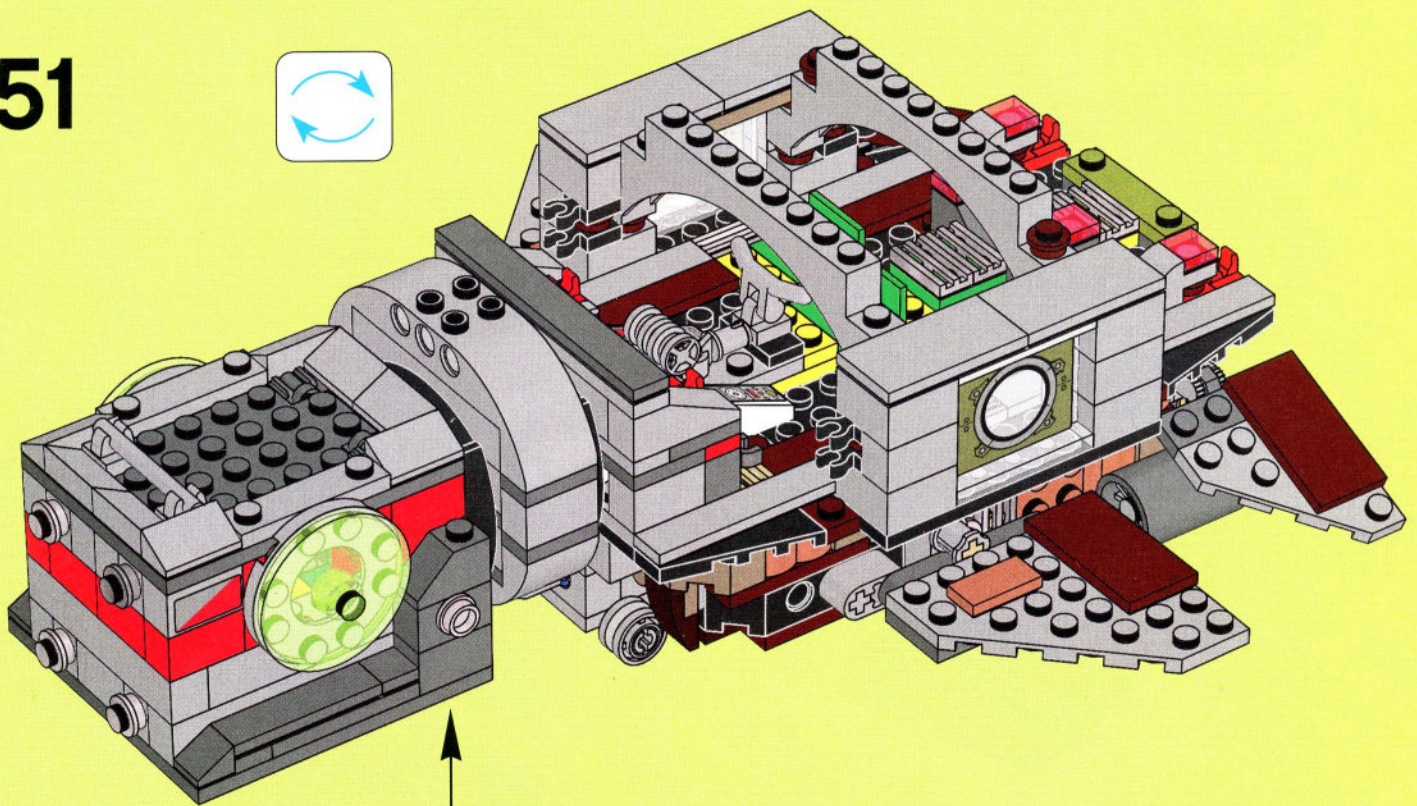

52

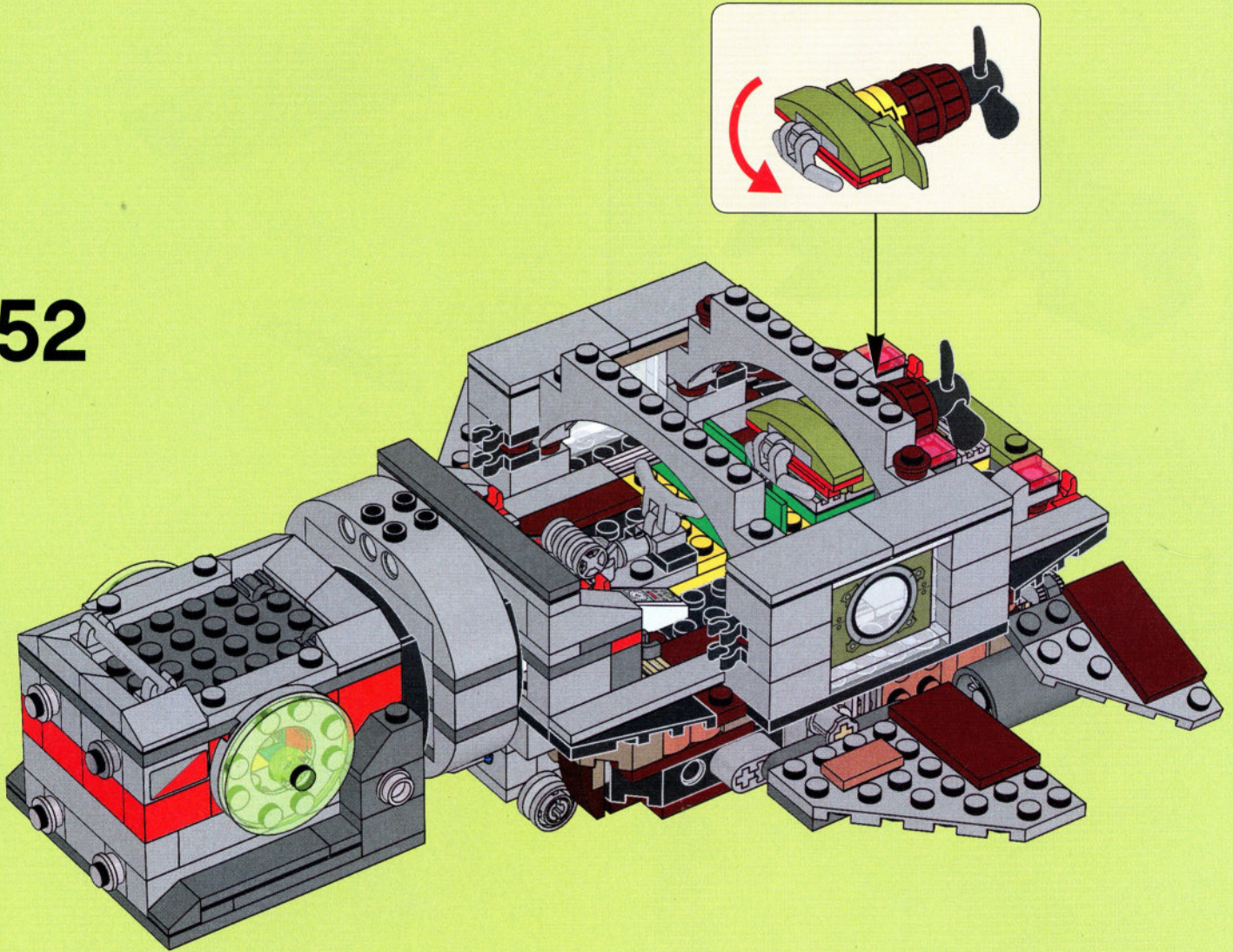

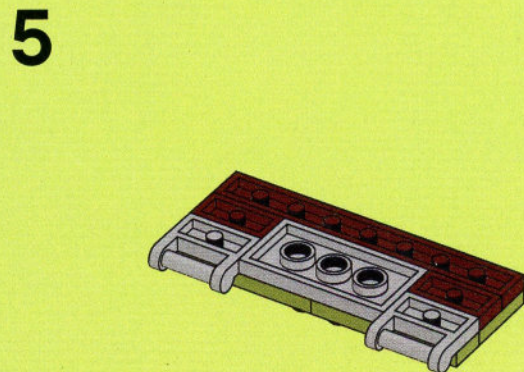
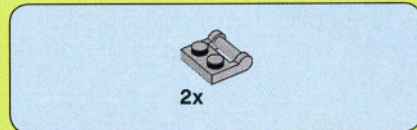
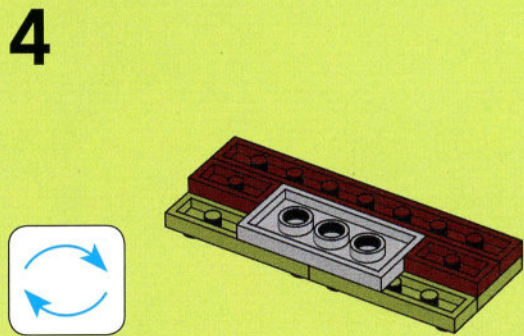
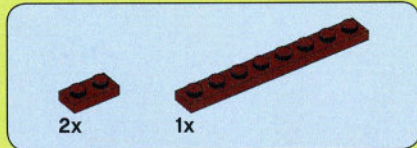
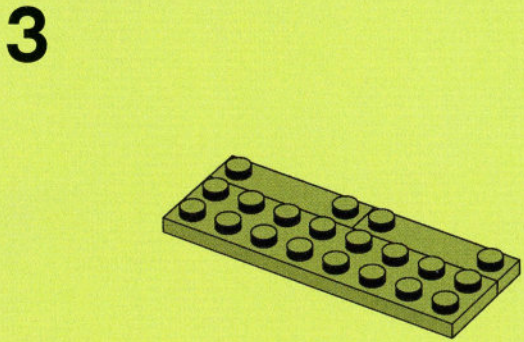
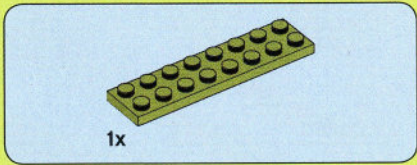
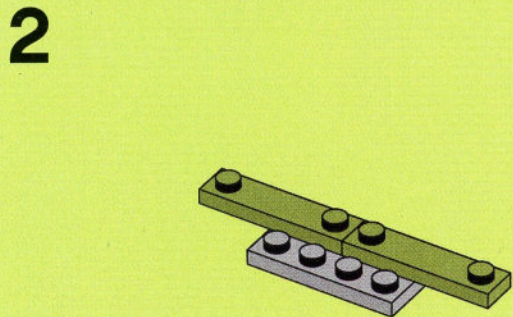
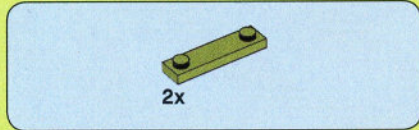
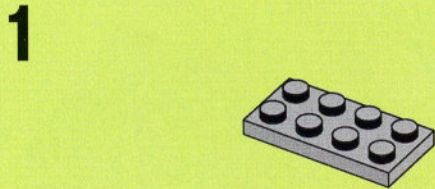
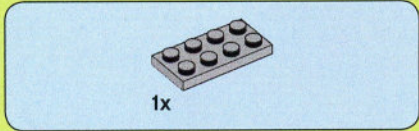
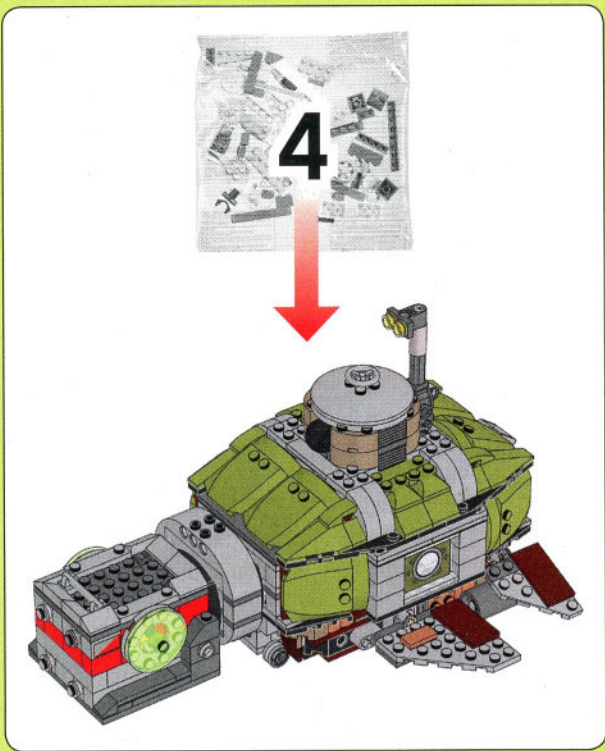



2x

6

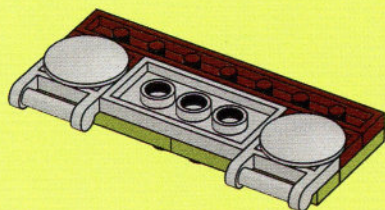

1x



1x

7

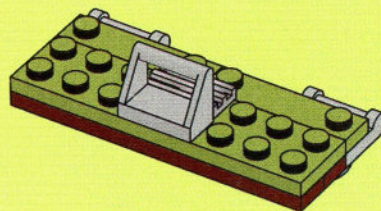

53

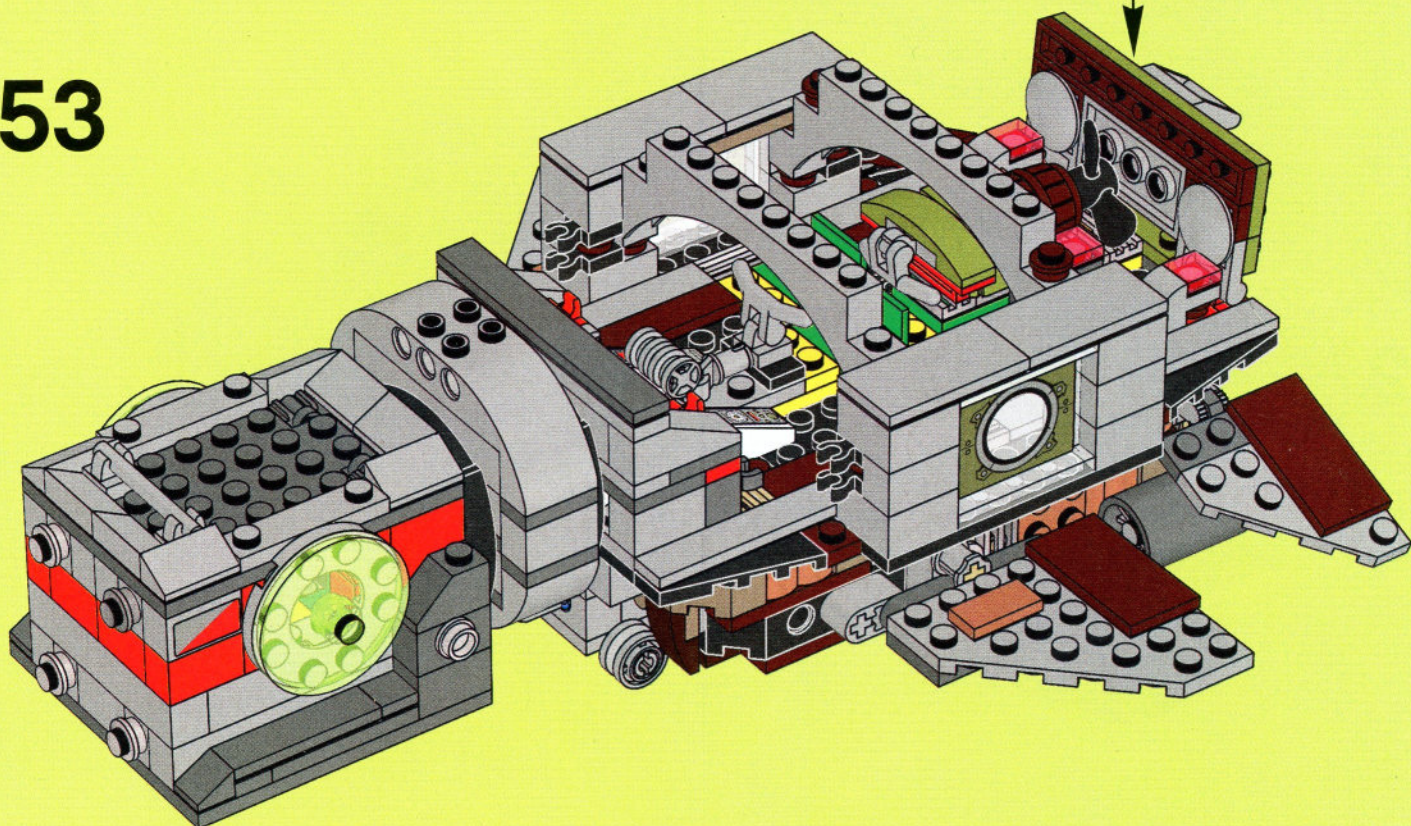



2x



1x



1x

1

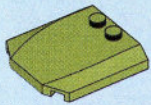
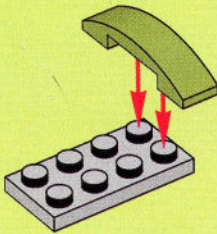

1x

2

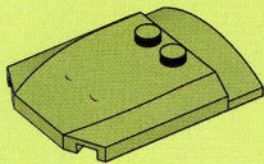

1x



1x

3

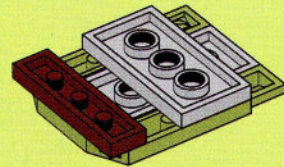

1x



1x

4

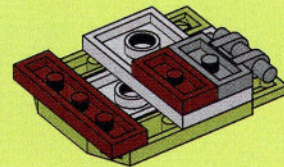

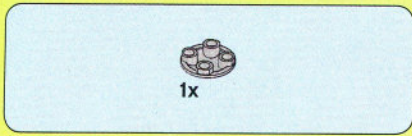

5

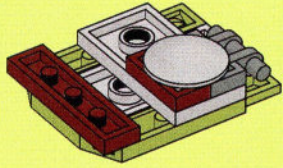

2x

54

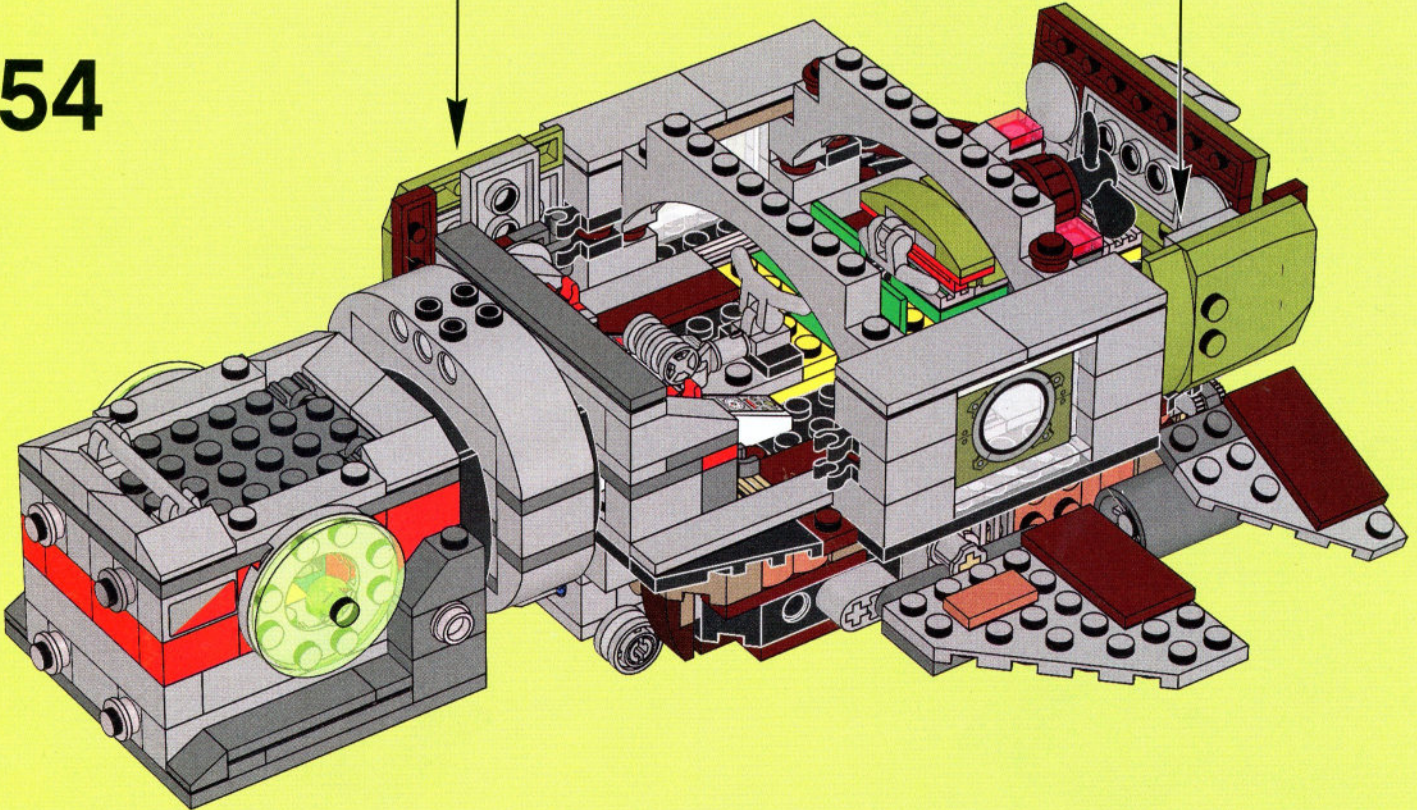



2x



1x



1x

1

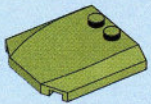
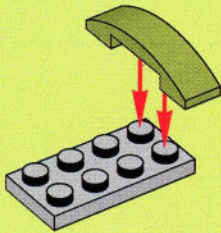

1x

2

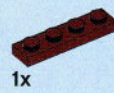
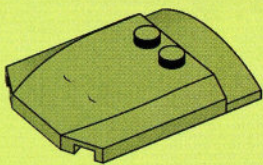

1x



1x

3

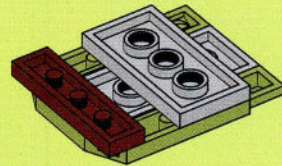

1x



1x

4

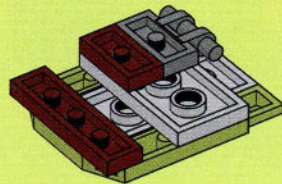



1x

5

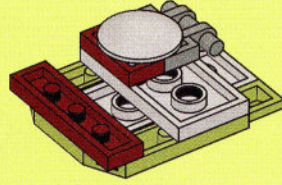

2x

55

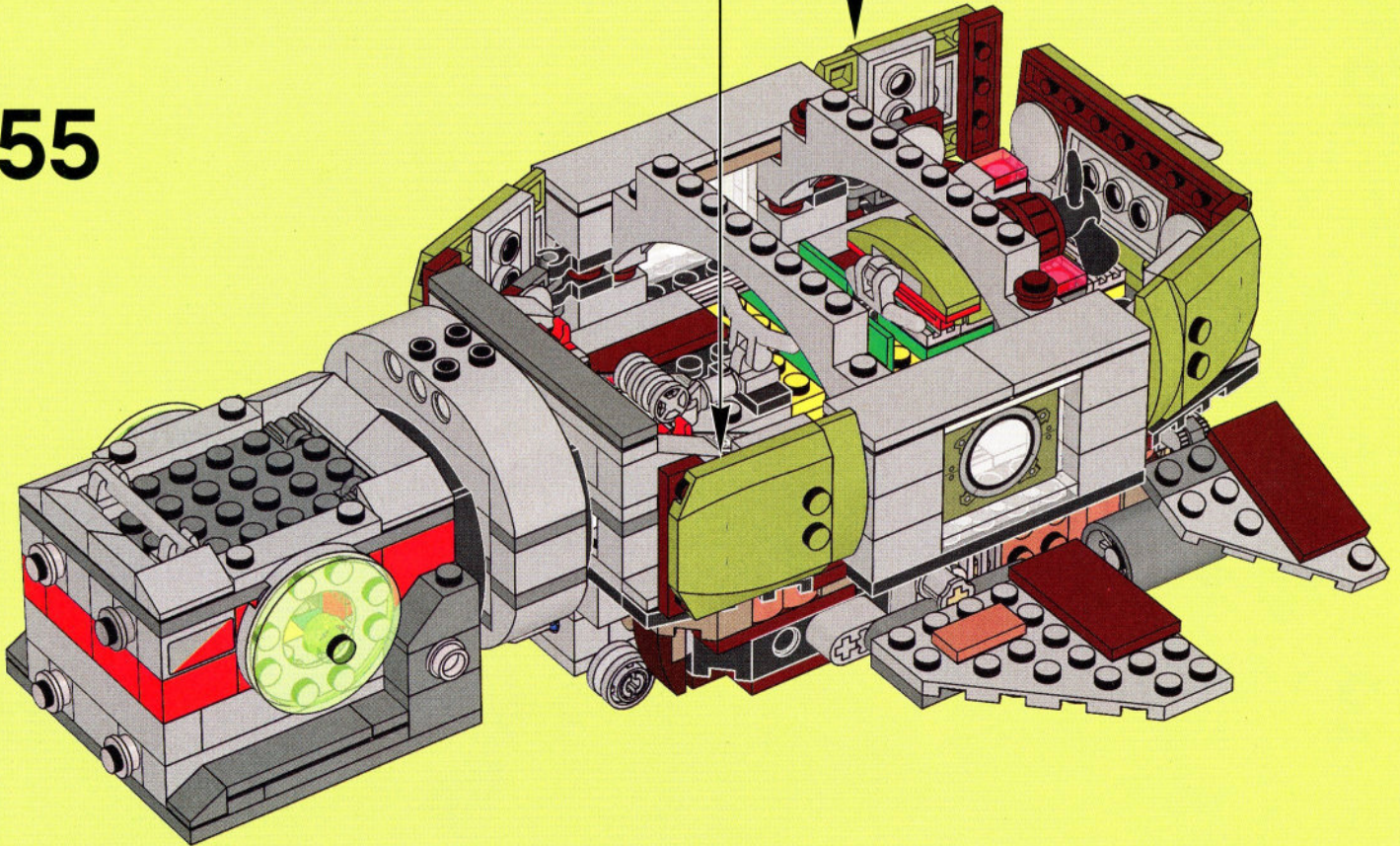

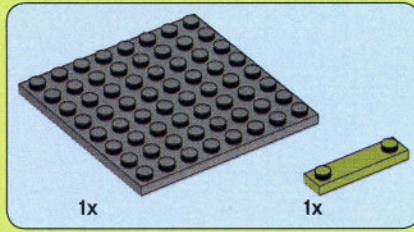
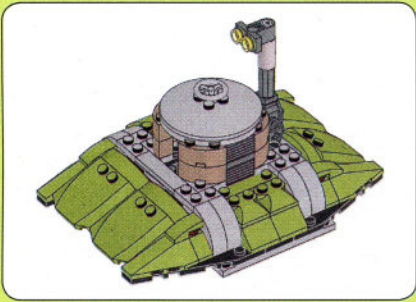

1

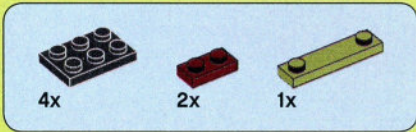
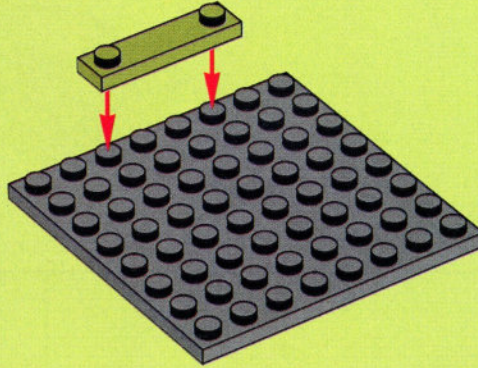

2

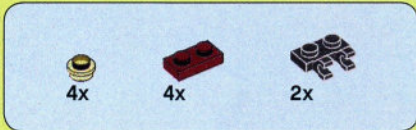
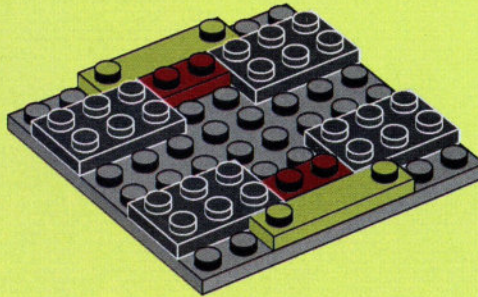

3

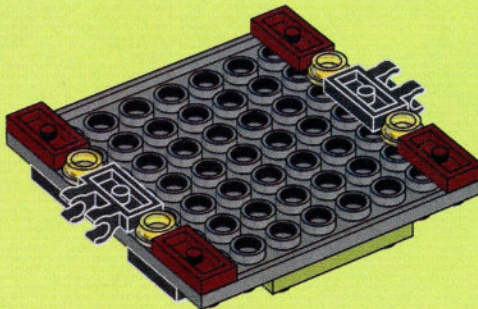

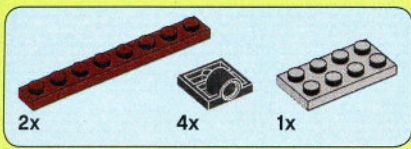

4

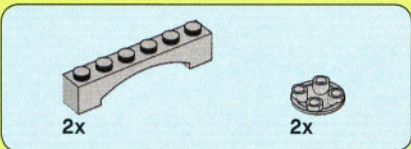
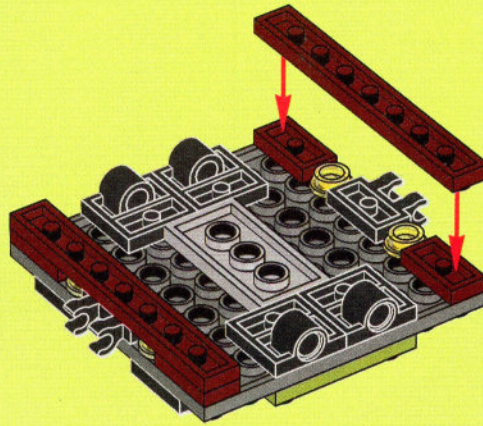

5

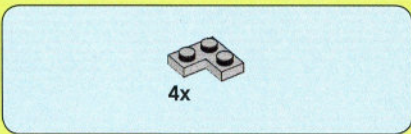
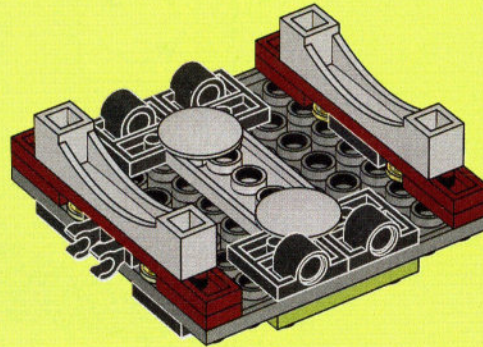

6

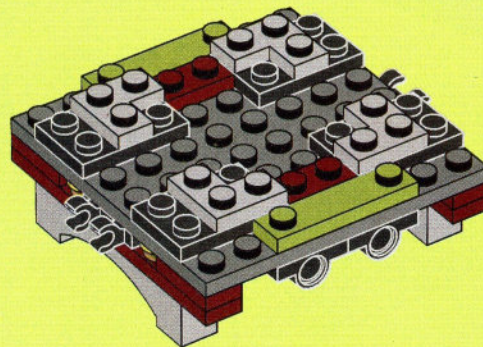

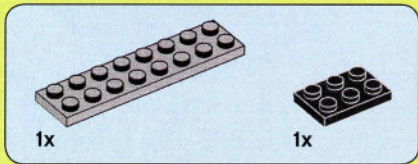
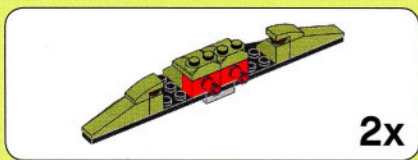

1

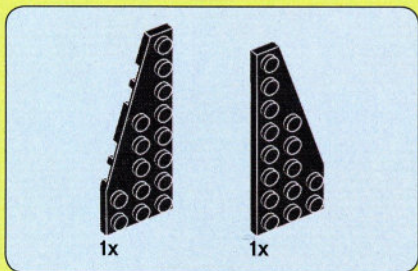
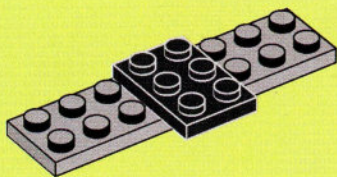

2

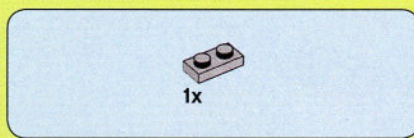
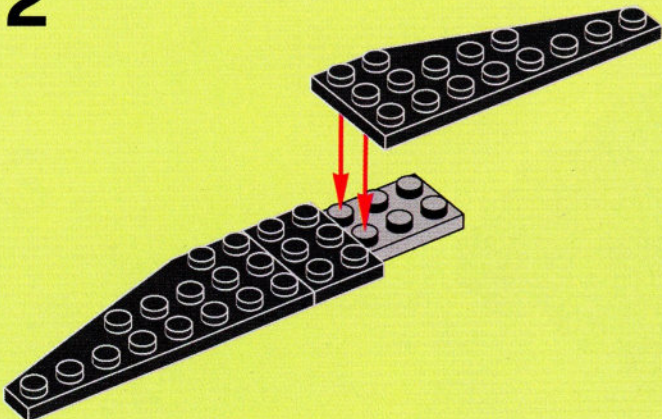

3

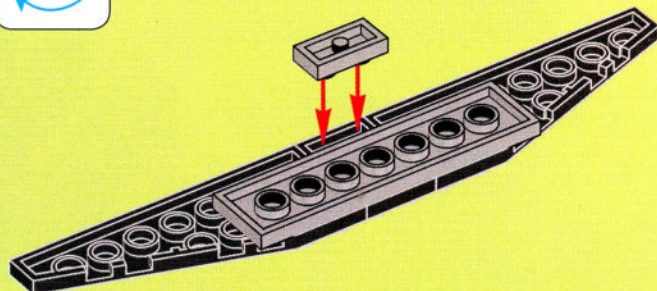

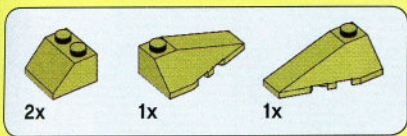

4

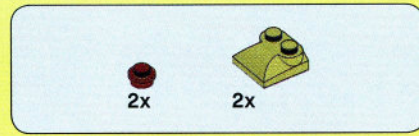
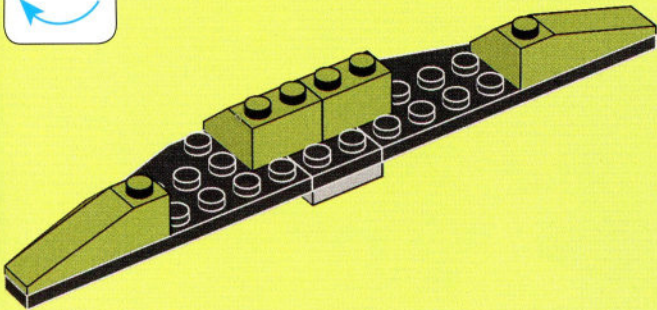

6

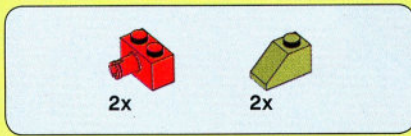
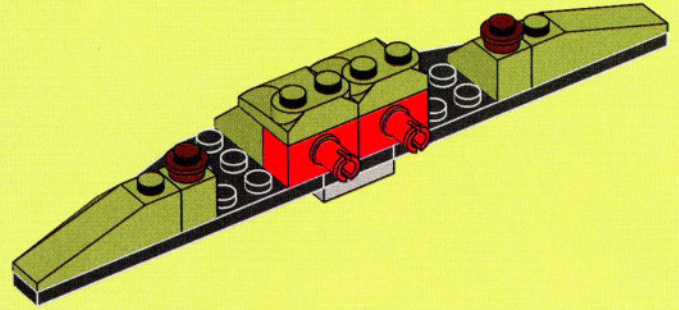

5

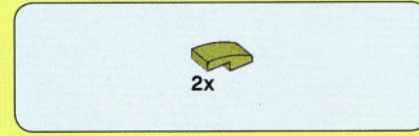
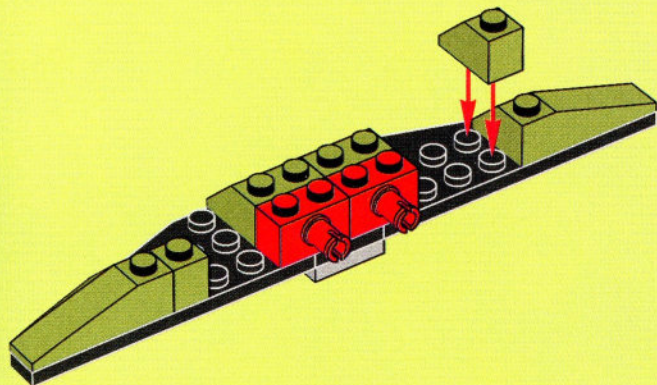

7

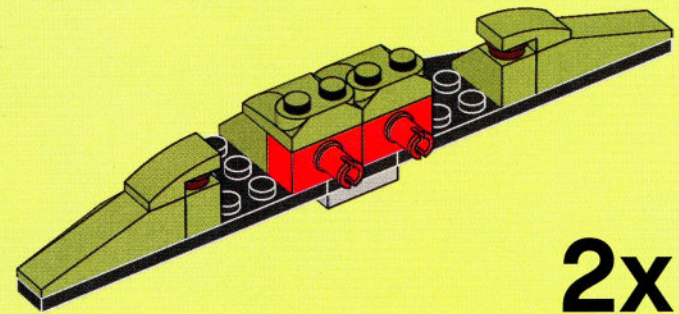

2x

7

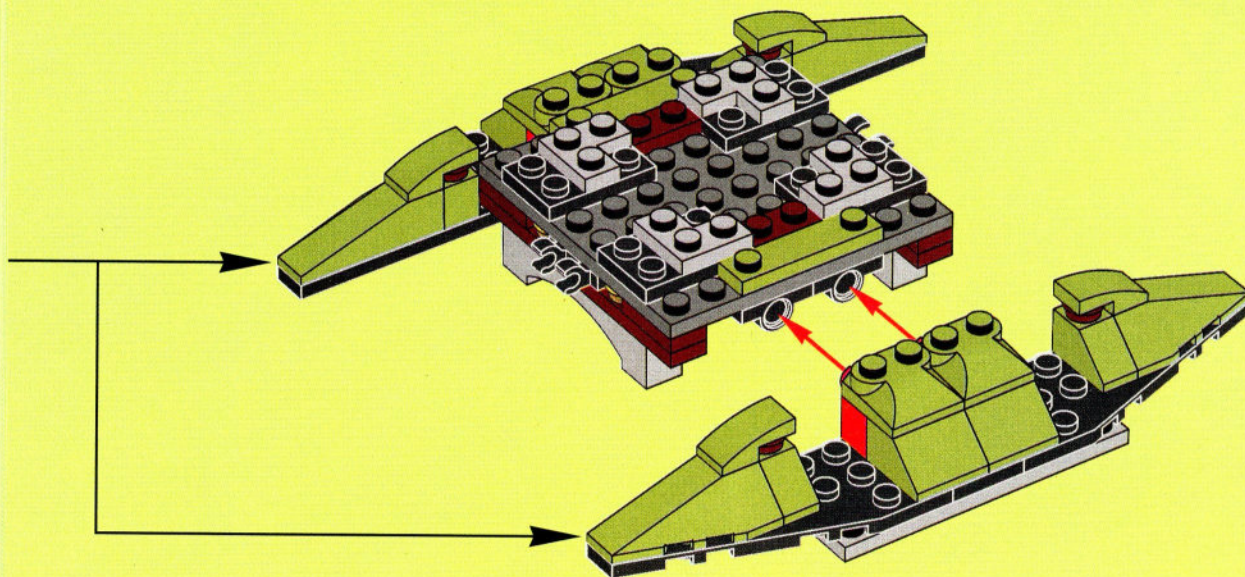

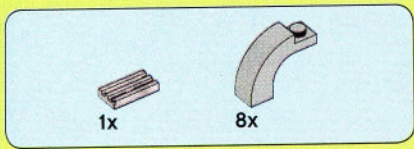

8

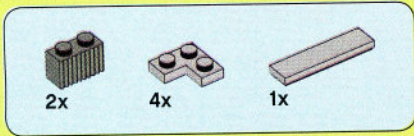
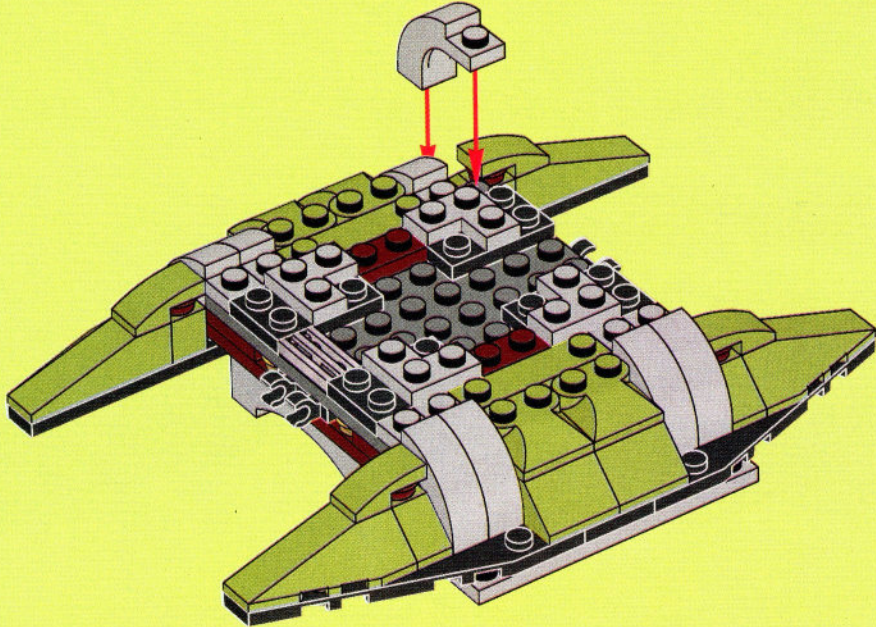

9

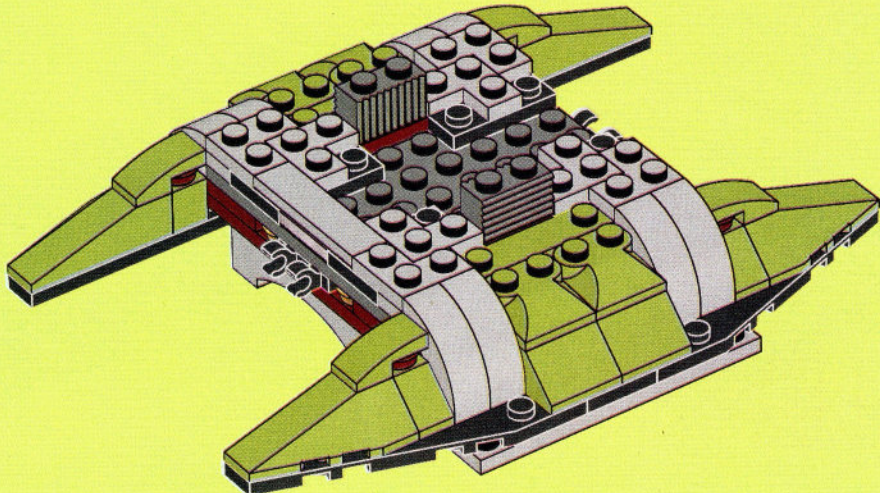



2x

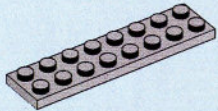

1x

1

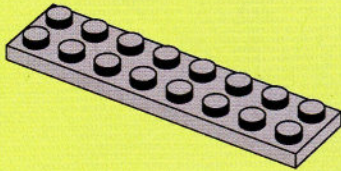

2x

2

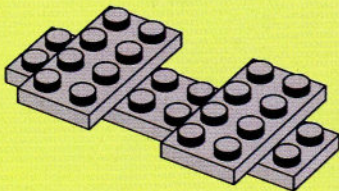

2x

3

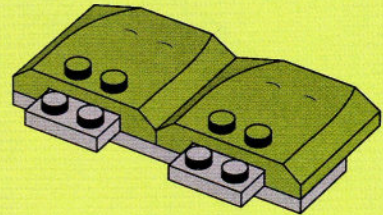

2x

4

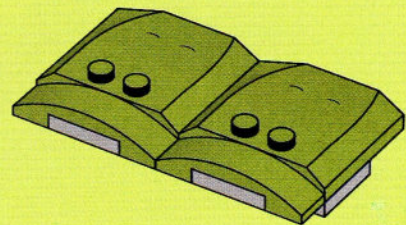

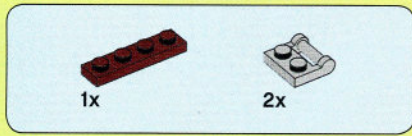

5

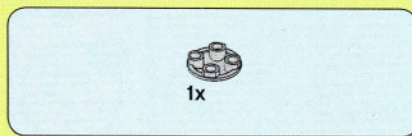
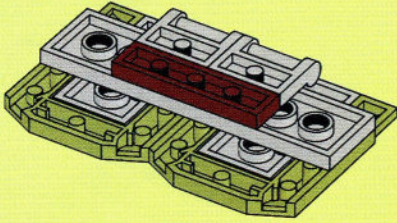

6

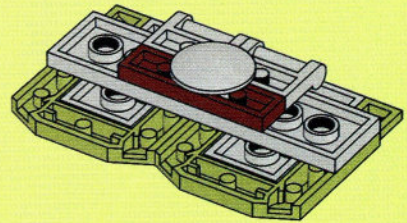

2x

10

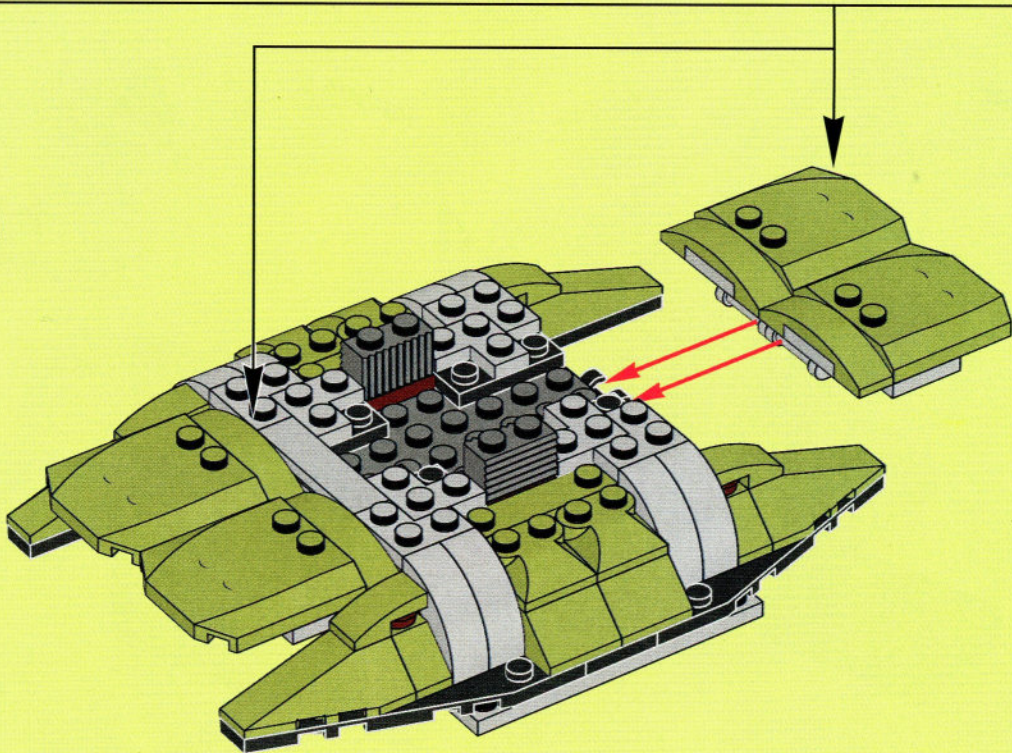

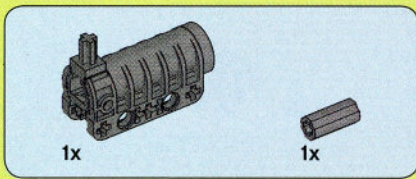

1

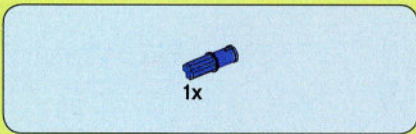
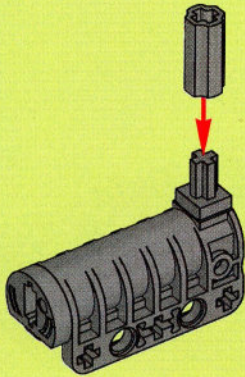

2

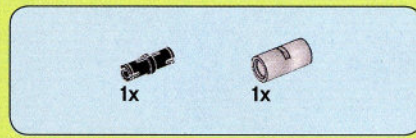
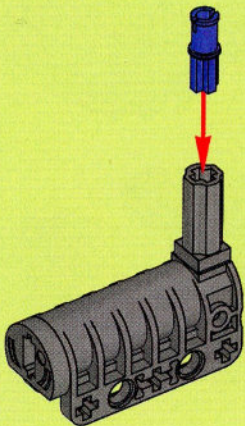

3

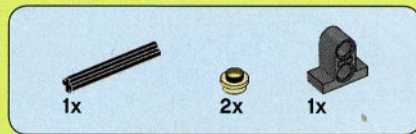
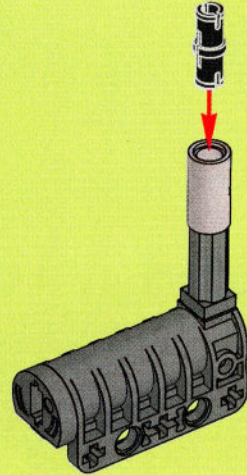

4

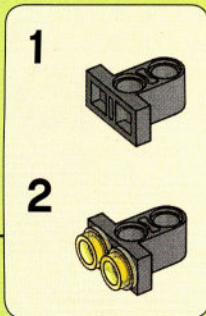
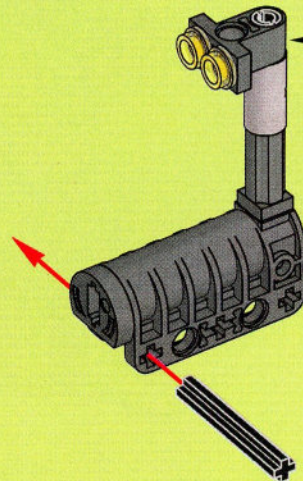



2x



2x

5

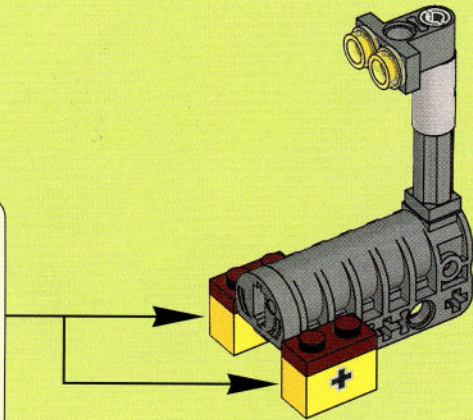
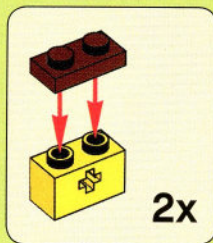

11

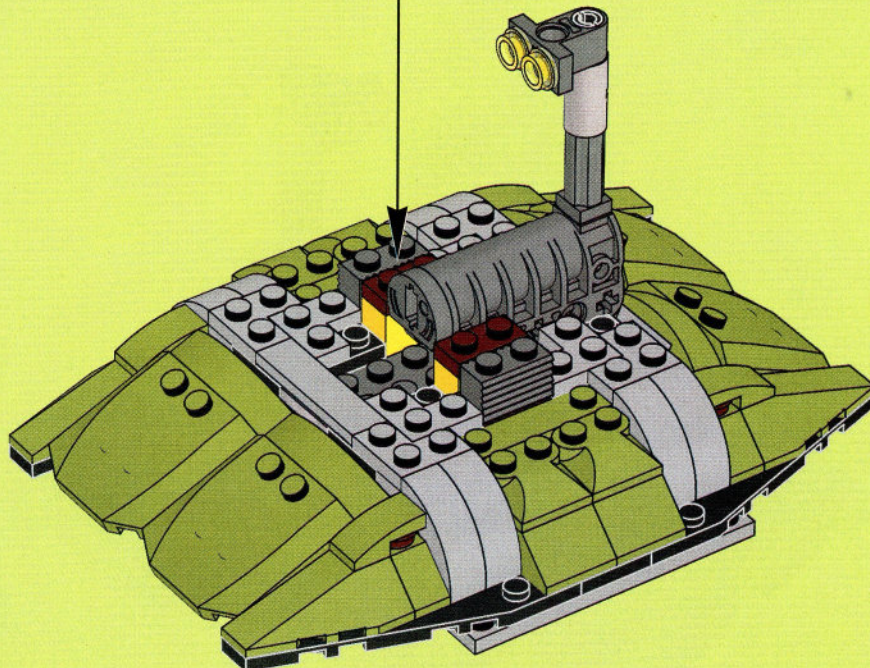

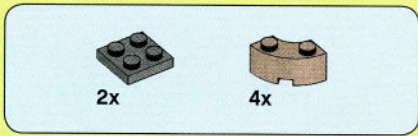

12

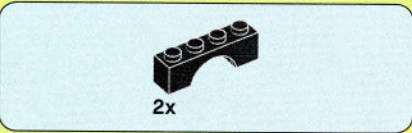
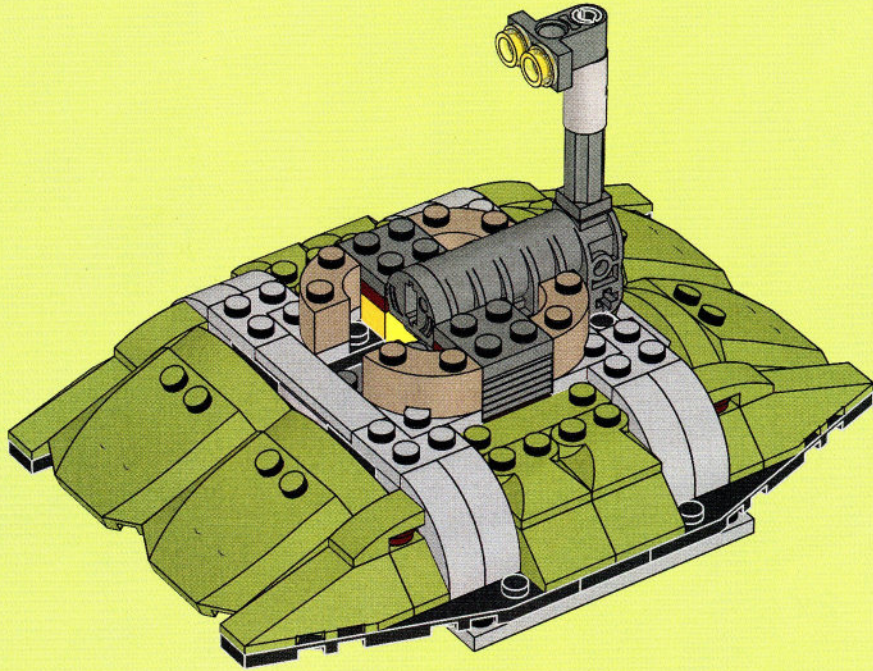

13

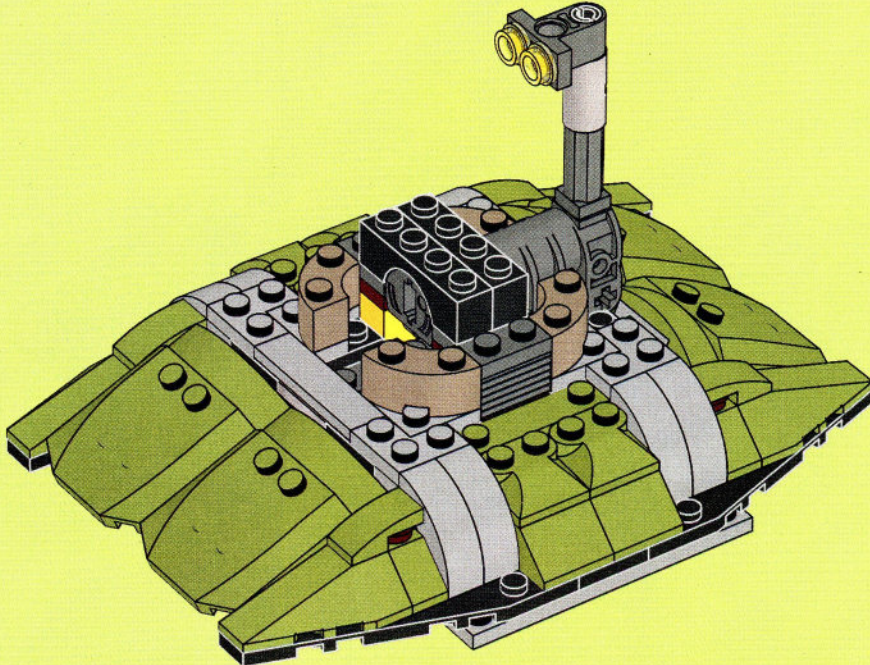



2x



4x

14

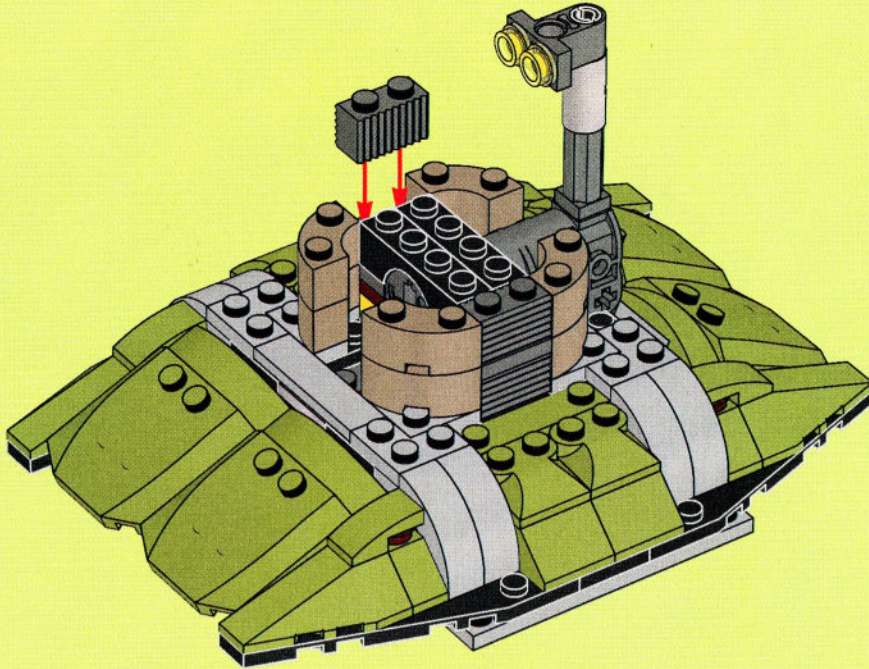

1x

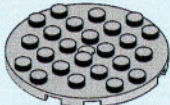

1x

15

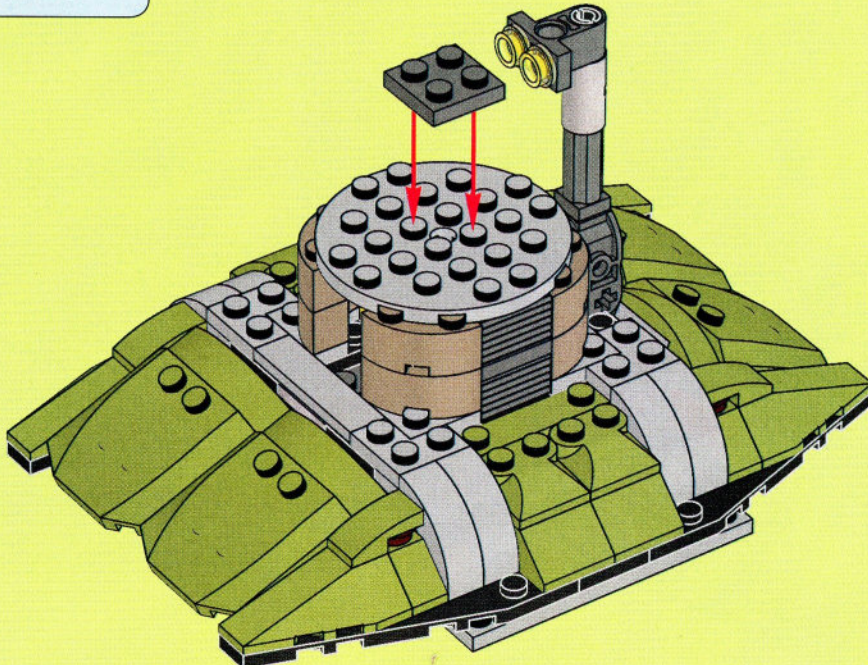

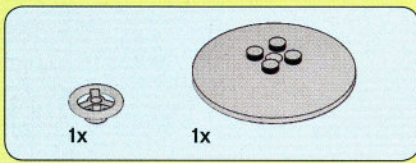

16

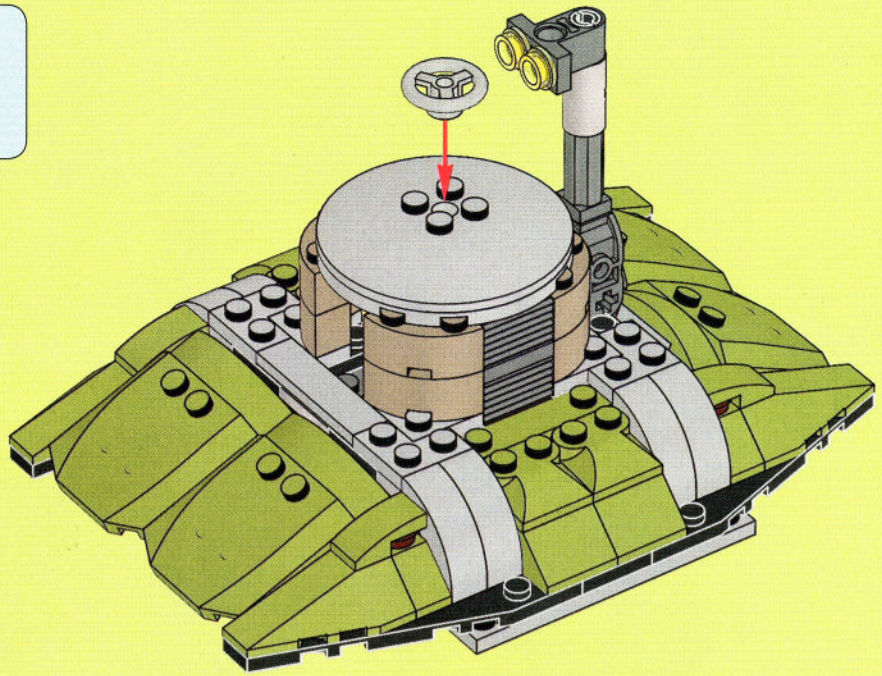

56

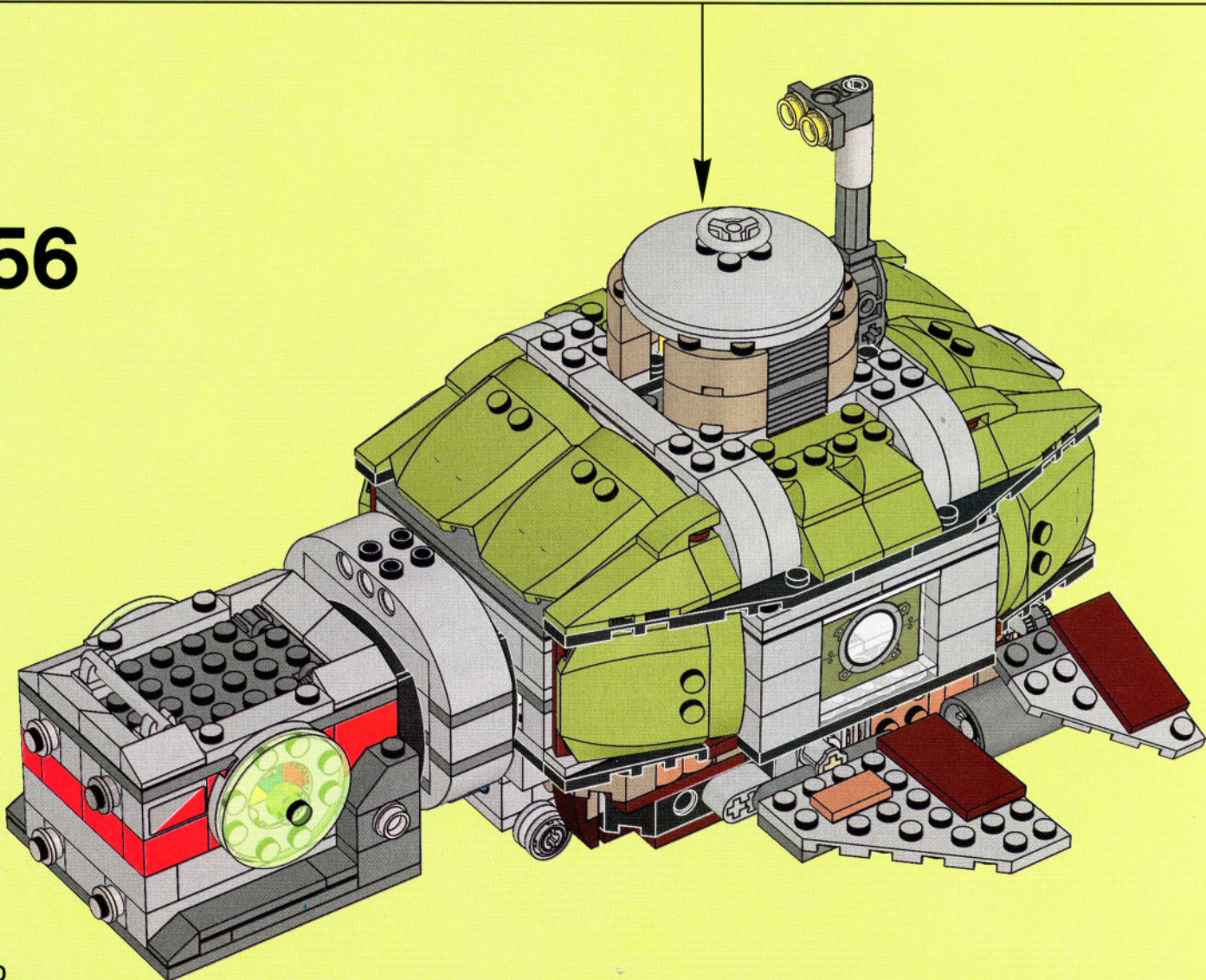

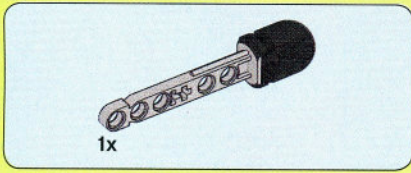

57

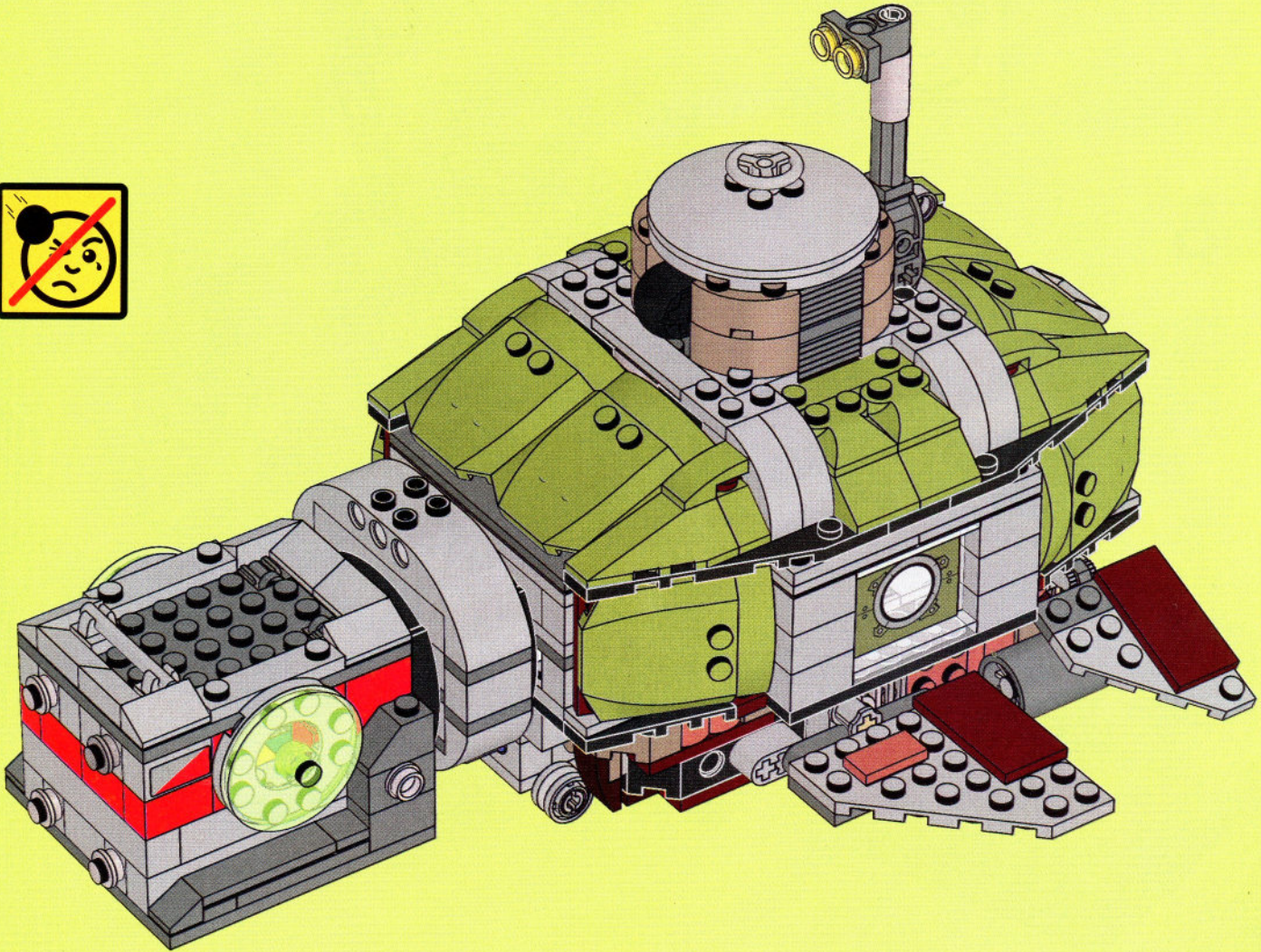



58

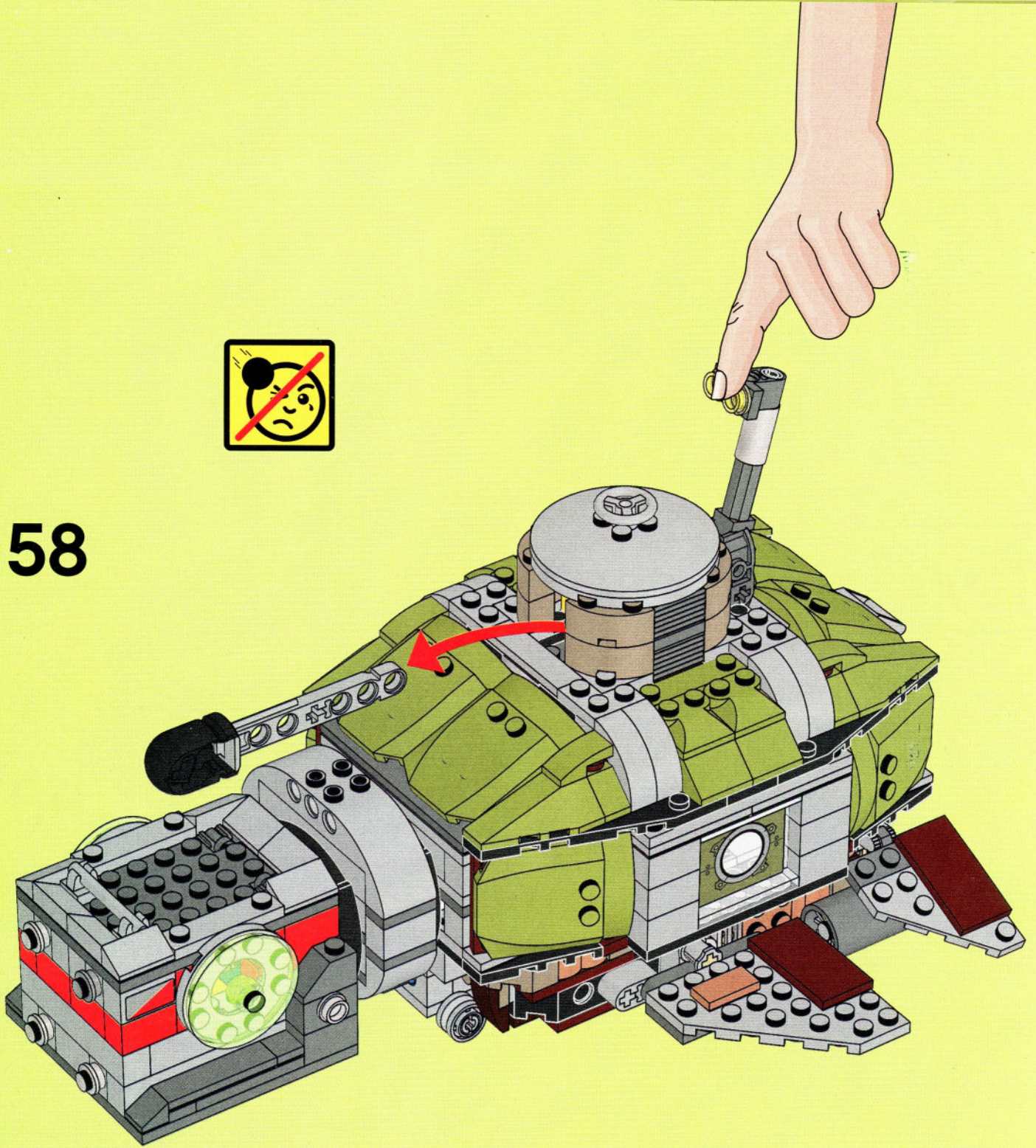

59

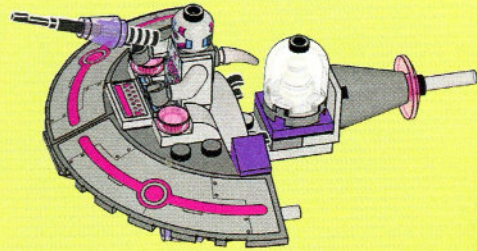
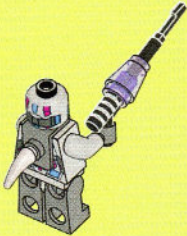
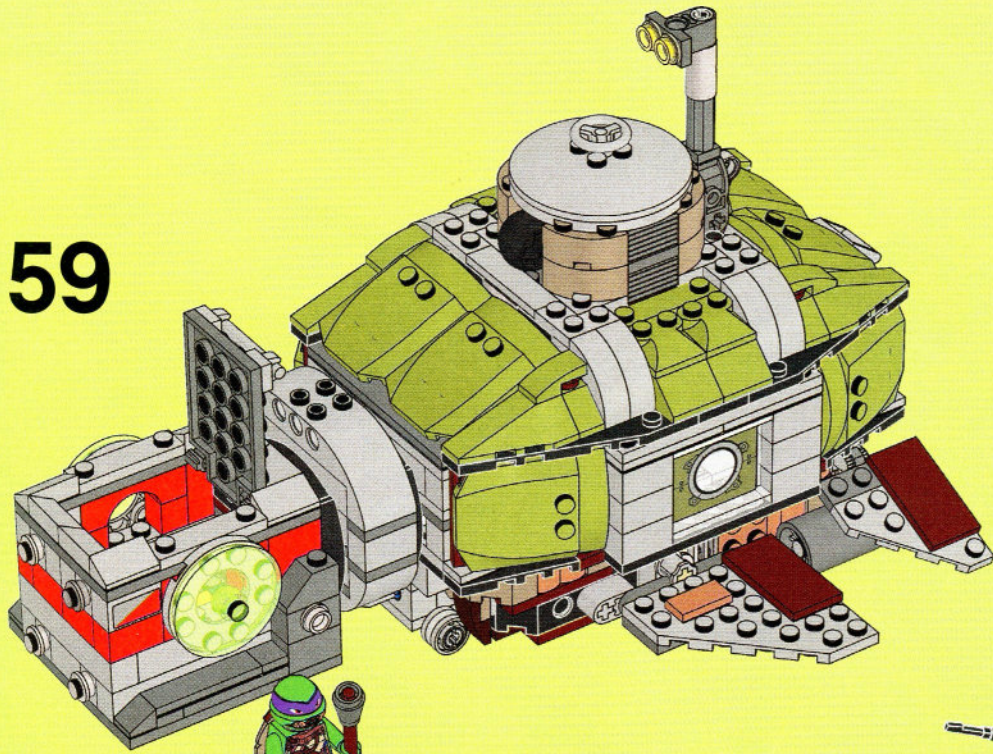



2x 300801
2x 4528417
1x 306801
2x 4201062
1x 4185273
4x 4124456
3x 6048857
5x 4666579
2x 4514554
2x 4143832
4x 300421
1x 300321
1x 300921
4x 4558886
6x 245821
2x 365921
11x 302321
1x 379421

4x 4597713
1x 6089576
1x 4142865
3x 4513174
2x 4140806
3x 302323
1x 302023
2x 614123
1x 4206482
6x 4514553
2x 4233484
5x 302324
1x 306824
1x 4560181
2x 379524
2x 403224
1x 4621603
2x 4239601
2x 6037390
4x 4558954
7x 370126

2x 4529549
6x 4613153
2x 365926
1x 379426
6x 302126
2x 303526
2x 303626
8x 4550017
2x 4144023
2x 6020193
2x 4556158
2x 4535739
4x 6061032
2x 4161332
2x 4160869
2x 4251394

2x 4251393
1x 73587
2x 6043130
1x 604126
2x 6028041
7x 4121715
1x 370526
3x 306928
1x 302228
4x 4522673
1x 6077751
1x 6077754
1x 6076596
1x 4113949
2x 4594686
2x 3003941
2x 4189801

6x 3005744
4x 4567340
1x 4544069
2x 3005749
2x 6024124
4x 6020847
8x 6001826
4x 4528604
2x 6015424
2x 6023062
1x 6070010
1x 6076787
2x 6069997
1x 4216615
2x 4620075
2x 6073014

1x 4658005
18x 4211150
4x 4211194
10x 4211190
4x 4579690
3x 4216945
4x 6055145
1x 4225715
20x 4216581
1x 4211147
1x 4538724
3x 6058134
1x 4531751
1x 6025366
1x 6077748
1x 6076613
4x 6064670
4x 6016474

2x 6064659
2x 6064662
4x 6031787
9x 6016482
5x 6024727
1x 6073988
1x 6016462
8x 6024696
4x 6073984
11x 4619636
10x 4633691
2x 4612900
2x 4612901
1x 6054858
2x 6046943
2x 4519946
2x 6070270
6x 4651231
2x 6021997
2x 6056383



Customer Service
 Kundenservice
 Service Consommateurs
 Servicio Al Consumidor
 LEGO.com/service or dial



: 00800 5346 5555
 : 1-800-422-5346







LEGO.com/turtles

79118



79119



79120



79121





WIN!

Go to LEGO.com/productfeedback to fill out a survey for a chance to win a cool LEGO® Product.
No purchase necessary.
Open to all residents where not prohibited.



LEGO.com/productfeedback

GEWINNE!

Nimm an der Umfrage auf LEGO.com/productfeedback teil und hab die Chance ein cooles LEGO® Produkt zu gewinnen!
Die Teilnahme am Gewinnspiel führt zu keinerlei Kaufverpflichtungen. Teilnahme in allen nicht ausgeschlossenen Ländern möglich.

WIN!

Ga naar LEGO.com/productfeedback, vul een enquêteformulier in en maak kans op een cool LEGO® product.
Geen aankoopverplichting.
Iedereen mag deelnemen, uitgezonderd ingezetenden van landen waar een enquêteverbod geldt.

GAGNE!

Visite LEGO.com/productfeedback pour répondre à un questionnaire et avoir une chance de gagner un produit LEGO® très cool!
Aucune obligation d'achat.
Ouvert à tous les résidents des pays autorisés.

当てよう!

LEGO.com/productfeedbackにアクセスして、アンケートにご記入ください。当選者にはレゴ製品を差し上げます。
お買い上げの必要はありません。
禁止されていない限り、すべての皆様にご利用いただけます。

