

# TEENAGE MUTANT NINJA TURTLES®

## AIR NINJA™ LEONARDO®

1. Push button on jetpack to extend spring loaded flight wings! (\*note: some packs require tail fin to be manually pulled down).

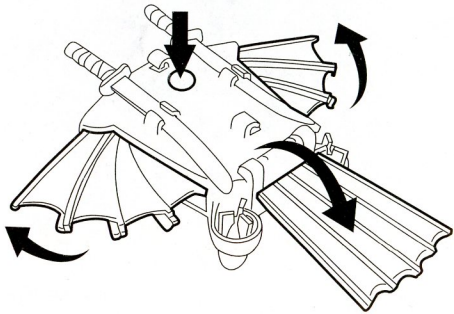

4. Hold the Levitation platform with one hand. With the other, pull winch hook down to extend life saving line.

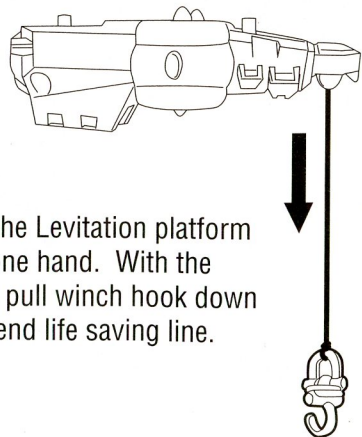

2. On back, secure the jetpack to shell. Leonardo's jetpack can hold his weapons in case of mid flight attack!

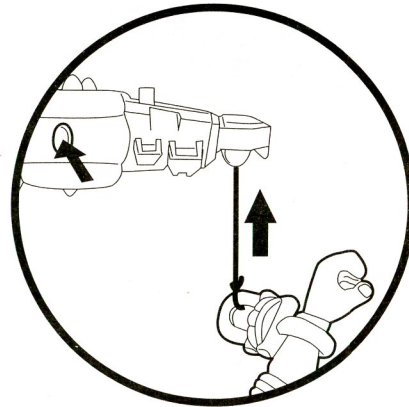
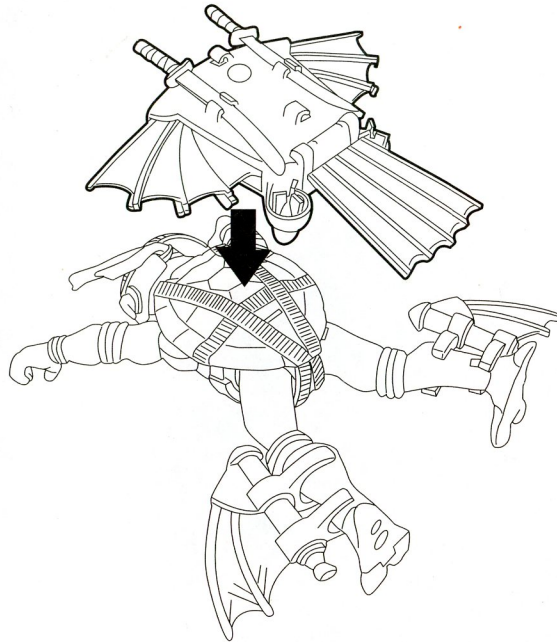

5. Attach winch hook to the wrist of Leonardo. Pull the line down. Press button on the side to activate zip line action!

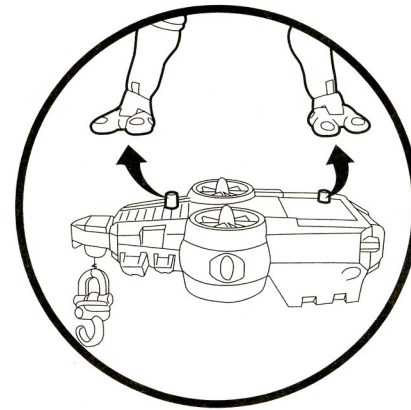

6. Leo rides on top of the levitation platform by inserting the pegs into the holes on the bottom of the figure's feet.

3. Set up fly line to two safe spots using hooks on either end. Be sure to set it up at an angle and use the two small grips on the jetpack to attach to the line. Place figure at highest end of the line to watch him zip down in awesome Air Ninja action!

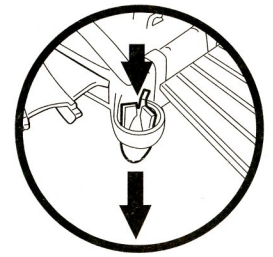
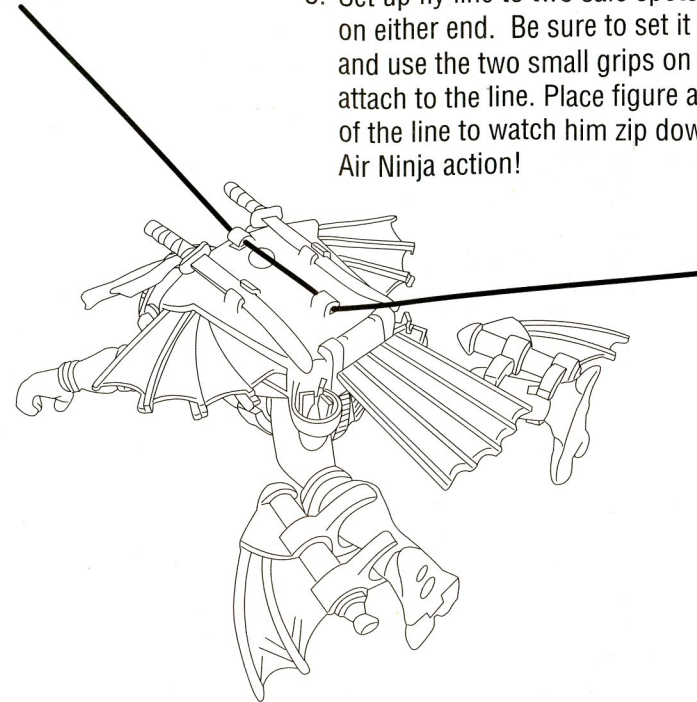

7. Push the two grenades down, on either of Leo's sides, to launch his busting bombs!

Age 4 and up

**Playmates®** ASST. NO. 54350  
STOCK NO. 54351

Teenage Mutant Ninja Turtles® © 2005 Mirage Studios, Inc. Teenage Mutant Ninja Turtles®, Leonardo®, Michelangelo®, Raphael®, Donatello®, Splinter®, Shredder®, and April O'Neil® are registered trademarks of Mirage Studios, Inc. All Rights Reserved.  
PRINTED IN CHINA.

**⚠️ WARNING: CHOKING HAZARD**  
Small parts. Not for Children under 3 years.